

INSTRUCTIONS  
FOR USE

# A-dec 500

DENTAL SYSTEM

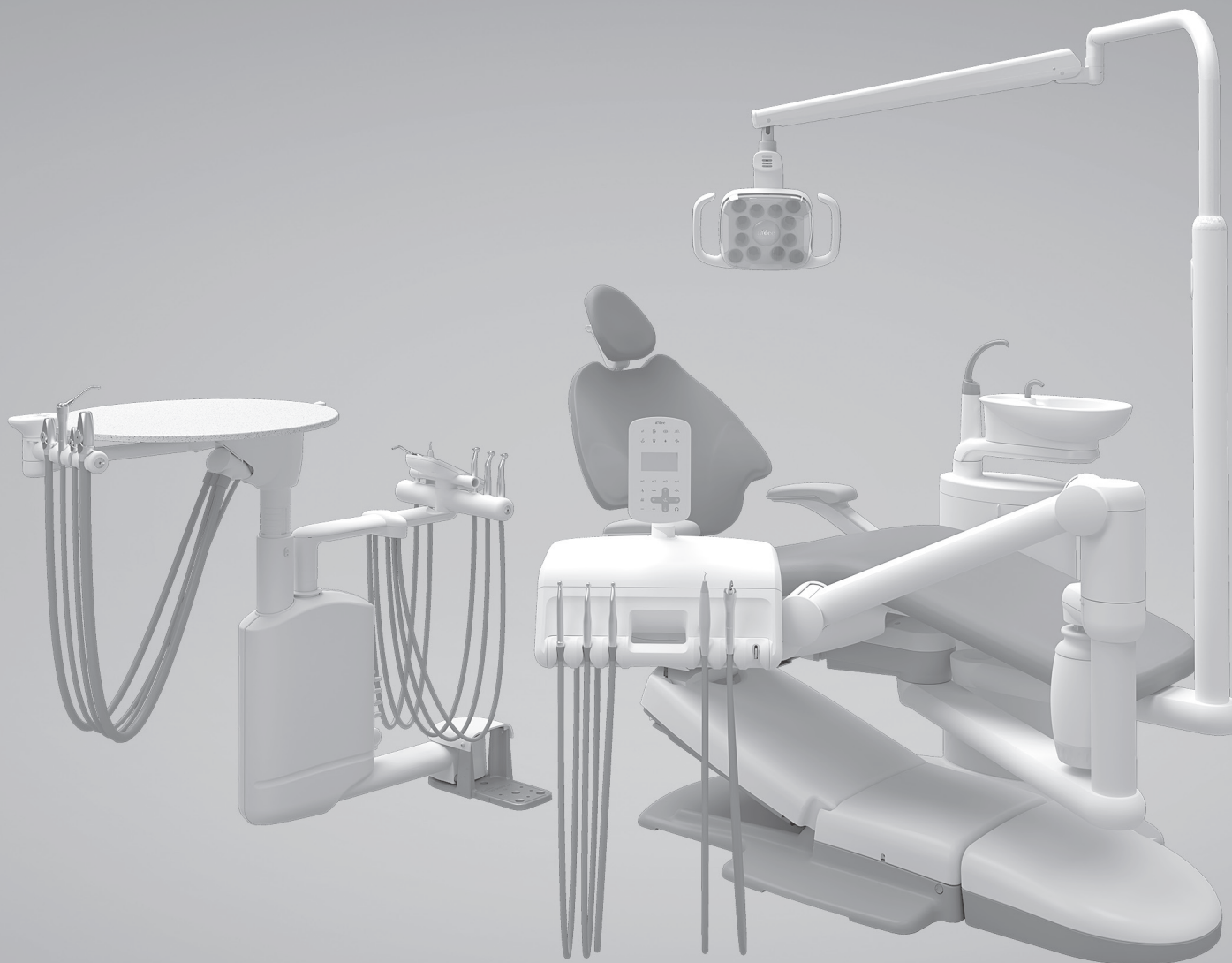

a dec

## Copyright

© 2020 A-dec Inc. All rights reserved.

A-dec Inc. makes no warranty of any kind with regard to this material, including, but not limited to, the implied warranties of merchantability and fitness for a particular purpose. A-dec Inc. shall not be held liable for any errors contained herein or any consequential or other damages concerning the furnishing, performance or use of this material. The information in this document is subject to change without notice. If you find any problems in the documentation, please report them to us in writing. A-dec Inc. does not warrant that this document is error-free.

No part of this document may be copied, reproduced, altered, or transmitted in any form or by any means, electronic or mechanical, including photocopying, recording, or by any information storage and retrieval system, without prior written permission from A-dec Inc.

## Trademarks and Additional Intellectual Property Rights

A-dec, the A-dec logo, A-dec Inspire, Cascade, Century Plus, Continental, Decade, ICX, ICV, Performer, Preference, Preference Collection, Preference ICC, Radius, and reliablecreativesolutions are trademarks of A-dec Inc. and are registered in the United States and other countries. A-dec 500, A-dec 400, A-dec 300, A-dec 200, and EasyFlex are also trademarks of A-dec Inc. None of the trademarks or trade names in this document may be reproduced, copied, or manipulated in any manner without the express, written approval of the trademark owner.

Certain touchpad symbols and icons are proprietary to A-dec Inc. Any use of these symbols or icons, in whole or in part, without the express written consent of A-dec Inc., is strictly prohibited.

## Contradiction

None.

## Production Date

See the label.

## Spare Parts List

For details of product accessories, wear and tear parts and their use methods, refer to the detailed description of each component.

## Regulatory Information and Warranty

For required regulatory information and the A-dec warranty, see the *Regulatory Information, Specifications, and Warranty* document (p/n 86.0221.00) available in the Resource Center at [www.a-dec.com](http://www.a-dec.com).

## Product Service

Product service is available through your local authorized A-dec dealer. To locate an authorized dealer, or for additional service information, visit [www.a-dec.com](http://www.a-dec.com) or contact A-dec at 1.800.547.1883 in the USA and Canada or 1.503.538.7478 worldwide.

## Product Models and Versions Covered in This Document

Model	Version	Description
511	B	Dental Chair
532/533/541	B	Delivery System
545, 551	A	Assistant's Instrumentation
461	A	Cuspidor
572L	A	Dental Light

## **Product Components**

Dental system is composed of dental Chair (511), delivery system (532, 533, 541), assistant arm (545, 551), dental light (572L), cuspidor (461).

## **Intended Use**

This product is used for diagnosis and surgery in the dental department.

## **Expected Service Life**

With proper maintenance and service, A-dec products are designed for a defined "Service Life", 20 years from the date of manufacture.

## **Product installation**

For information on the assembly and mounting of the dental unit, see the installation and pre-installation guides available in the Resource Center at [www.a-dec.com](http://www.a-dec.com).





# Content Map A-dec 500 Dental System

---

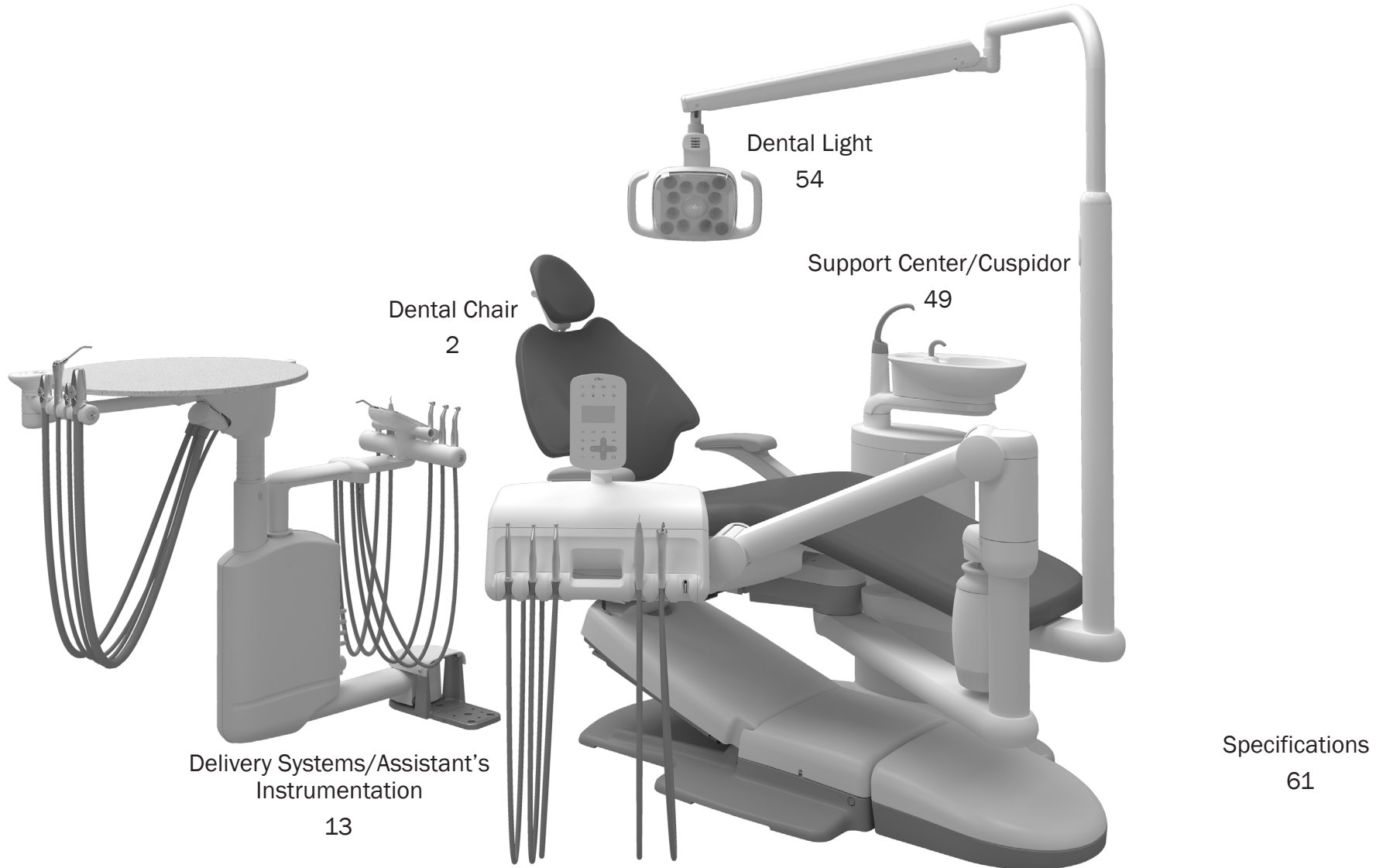

# Dental Chair

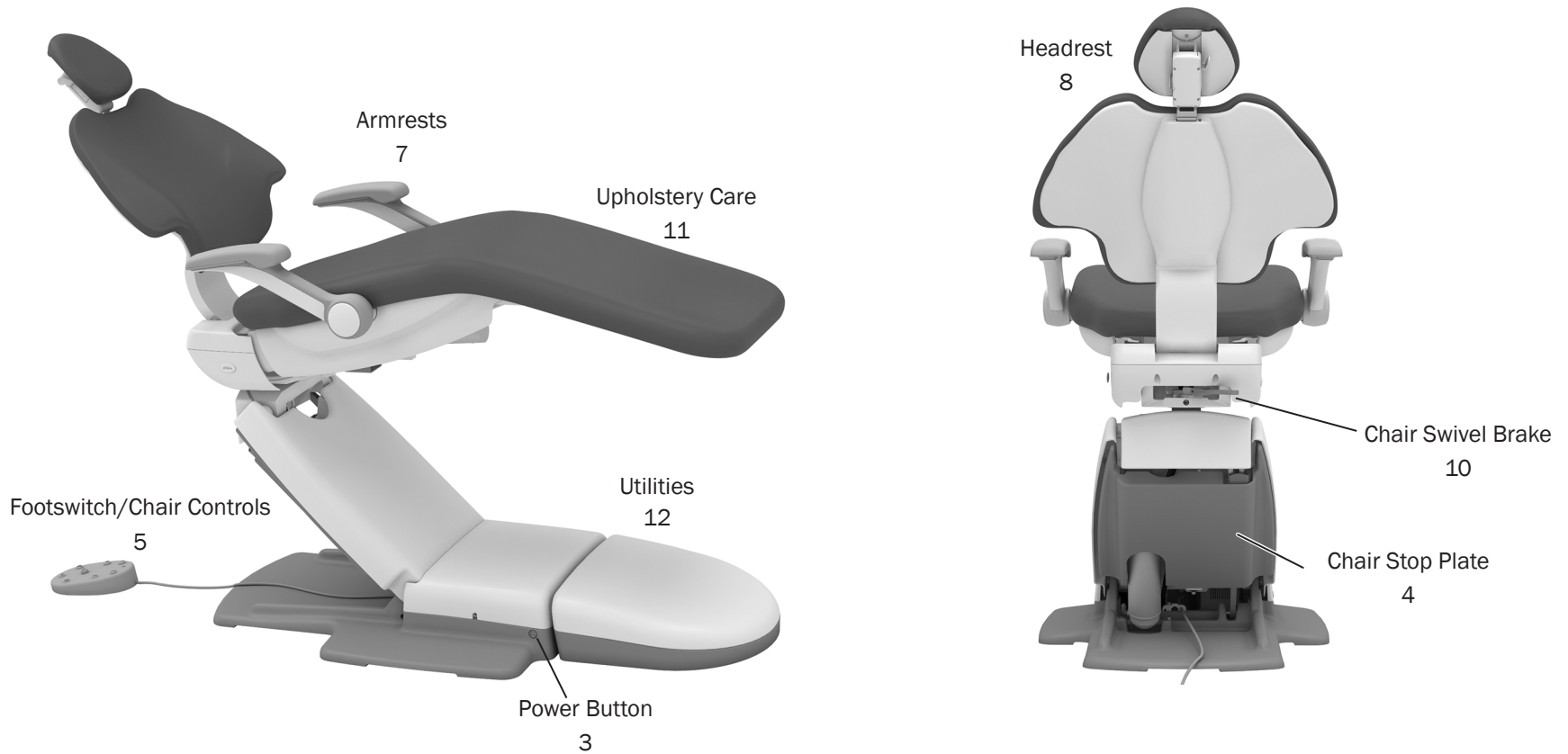

Operate / Adjust.....	3
Clean / Maintain.....	11
Specifications.....	61

# Operate / Adjust Dental Chair

## Turn On/Turn Off the Power



### Chairs with Delivery and Support Systems

If you have a chair with an attached system, use the master toggle to turn on the power, water, and air. The master toggle is normally located on the delivery system, but may instead be located on the support center or floor box on chairs without a delivery system.

If there is no power to the system, verify that the power button on the chair is pressed in. This button must be on in order for the master toggle to control system power.

### Chair-Only Configurations

If you have a chair-only configuration, press the power button on the chair to turn on or turn off the power.

### When to Turn Off the Power

To save energy and reduce the chance of air leaks, press the power button to turn off power at the end of the day and before longer periods of non-use.

## Chair Safety Features



A-dec dental chairs and systems include safety features (like the chair stop plate) that may stop or prevent the chair from moving. This may occur due to any of the following:

- There's an obstruction under the chair or attached module.
- The foot control disc or lever is pressed.
- A handpiece isn't properly seated in its holder.

### **If the Chair Stops Unexpectedly or Won't Move**

Check for and correct any of the conditions listed above. If an obstruction is blocking chair movement, use the touchpad or footswitch to raise the chair, then remove the obstruction.

## Position the Chair with Manual Controls

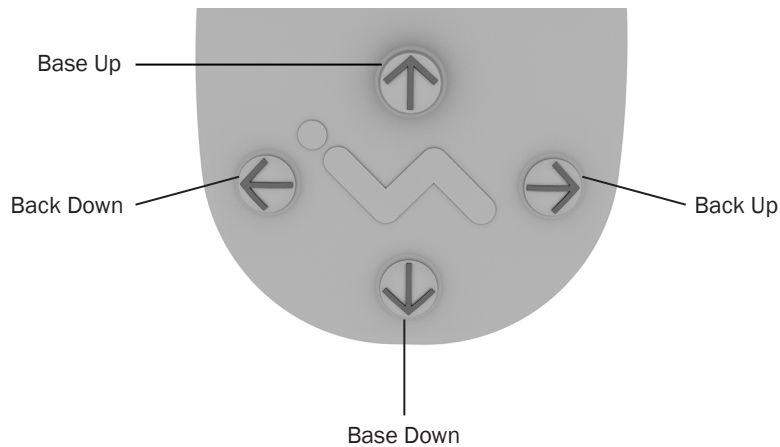
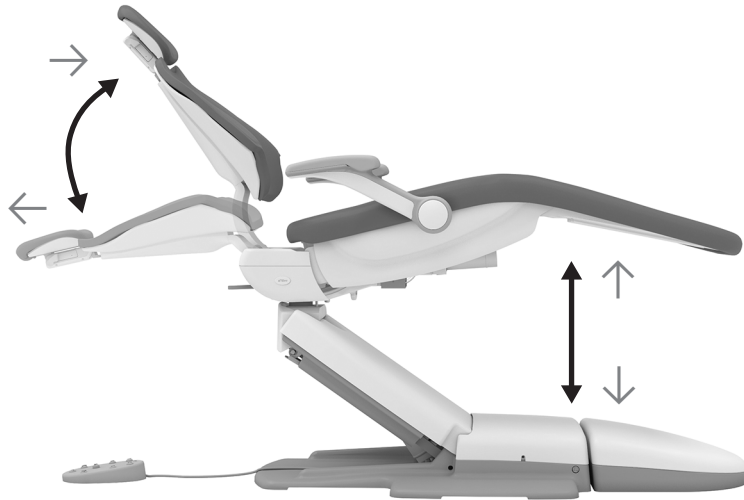

**IMPORTANT** The A-dec touchpad and footswitch move the chair in the same manner. See your delivery system Instructions for Use for detailed information about your touchpad controls.



**WARNING** Ensure that the patient is positioned safely before using the manual or preset chair controls. Never leave the patient unattended while the chair is in motion. Always take extra care with small children and patients with limited mobility.

To stop the chair at any point during preset movement, press any chair positioning button on the footswitch or touchpad.



**NOTE** If you would like to adjust the maximum height of your chair, contact your local authorized A-dec dealer.

Icon/Function	Actions/Options
↑ Base Up	Press and hold ↑ to raise the chair base.
↓ Base Down	Press and hold ↓ to lower the chair base.
→ Back Up	Press and hold → to raise the chair back.
← Back Down	Press and hold ← to lower the chair back.

## Position the Chair with Preset Controls

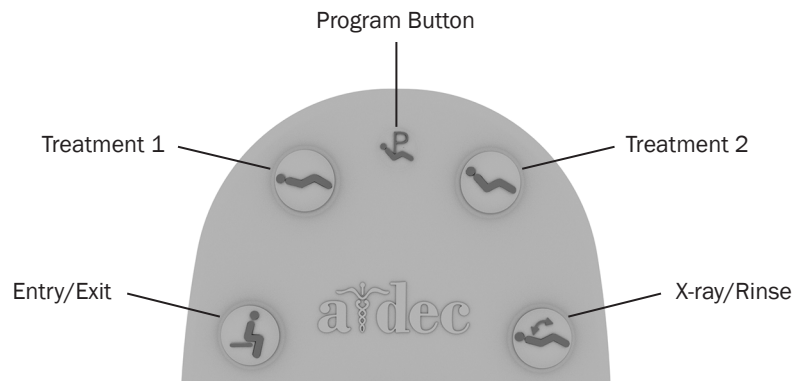

Icon	Preset Name	Factory Setting
	Entry/Exit	Positions the chair for patient entry/exit.
	Treatment 1	Positions the chair base and back down.
	Treatment 2	Positions the chair base down and the back partially up.
	X-Ray/Rinse	Moves the chair to either x-ray or rinse position. A second press moves the chair to the previous position.

Press , , , or to move the chair to a preset position. See the table (below left) for factory settings.

### Customize the Chair Preset Positions

To customize chair presets , , and :

1. Position the chair as desired.
2. Press and hold until you hear one beep, which indicates program mode is on.
3. Within five seconds, press the chair preset icon you want assigned to this new chair position (e.g., press ). Three beeps indicate that your new setting is saved.

### Customize the X-Ray/Rinse Chair Preset

The factory preset moves the chair and patient into an upright position for x-rays or cuspidor access. A second press of returns the chair to the previous position.

You can also set to function as a customized chair preset position. To change its function:

1. Press and at the same time and hold for three seconds.
  - One beep indicates is set as another customizable chair preset button.
  - Three beeps indicate that is set as the x-ray/rinse factory preset (which toggles between the x-ray/rinse position and the previous chair position).
2. If you set as another customizable chair preset and want to assign a different chair position, follow the steps outlined above in “Customize the Chair Preset Positions.”

## Prepare the Chair for the Patient

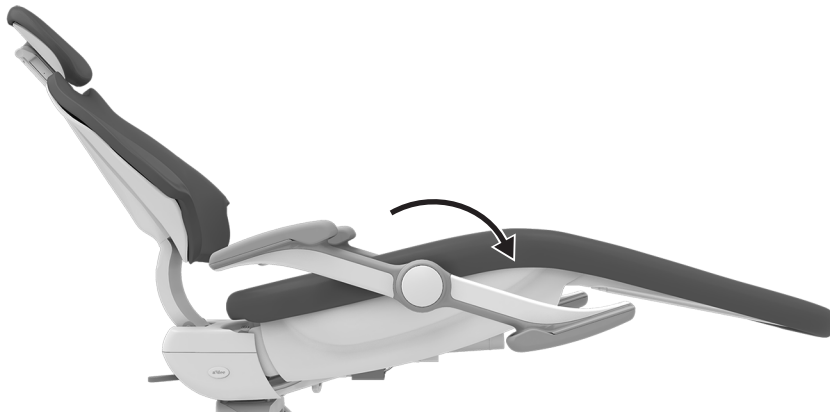

### Position the Armrests



**WARNING** Do not allow patients to drop their arms behind the armrests or under the backrest, or injury may occur when the chair moves.

Move the armrest out of the way to allow for easy patient entry/exit and improved operator access when working direct. Simply push or pull the armrest into position.

### Encourage a Proper Seating Position

To properly seat patients in the chair, ask them to sit as far back in the seat as possible. This ensures the best alignment with the lumbar support and comfort for the patient.

For optimal comfort, patients can place their forearms on the armrests or keep their arms comfortably folded on their lap.



**TIP** Before the patient sits down in the chair, leave the headrest at a higher position. This will encourage the patient to sit all the way back in the chair. Adjust the headrest once the patient is seated to improve patient comfort and operator access to the oral cavity.



**TIP** For patients who require additional support to exit the chair, leave the armrests in the back position.

## Position the Headrest

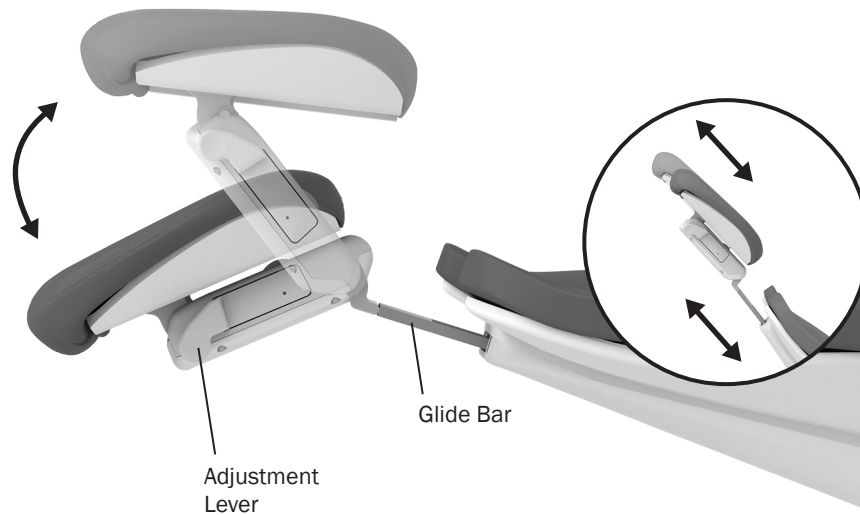

The dual-articulating gliding headrest includes several features you can use to improve access to the oral cavity and increase patient comfort.

Use the glide bar to accommodate a variety of patient heights. Simply pull up or push down on the headrest until it is in the desired position. The gliding headrest cushion provides additional height adjustment.



**WARNING** If the glide bar has exceeded its maximum recommended working height, a warning line will be visible on the patient's side of the glide bar. Do not use the headrest in a position where this warning line is visible.

You can easily adjust the headrest angle using one hand. Press the adjustment lever to position the headrest. Release, and the headrest holds its position.



## Position the Headrest for Wheelchairs



To position the headrest for wheelchairs:

1. Remove the headrest from the dental chair.
2. Rotate the headrest 180° and slide the glide bar into the backrest until it stops.
3. Swivel the dental chair, if necessary, and position the backrest to its full upright position.
4. Position the wheelchair and the dental chair back to back.
5. Move the dental chair up or down, as needed, to adjust the headrest height.
6. Lock the wheelchair wheels.

## Adjust the Headrest Glide Bar Tension

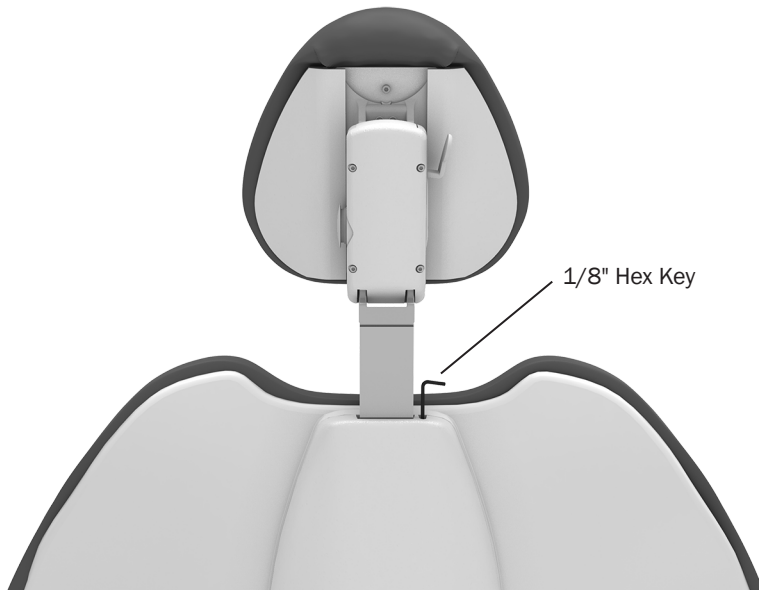

If the headrest drifts downward, or if it is difficult to move up or down, the glide bar tension needs adjustment.

To adjust the tension, use a 1/8" hex key. Turn the adjustment screw clockwise to increase tension.

## Operate the Chair Swivel Brake

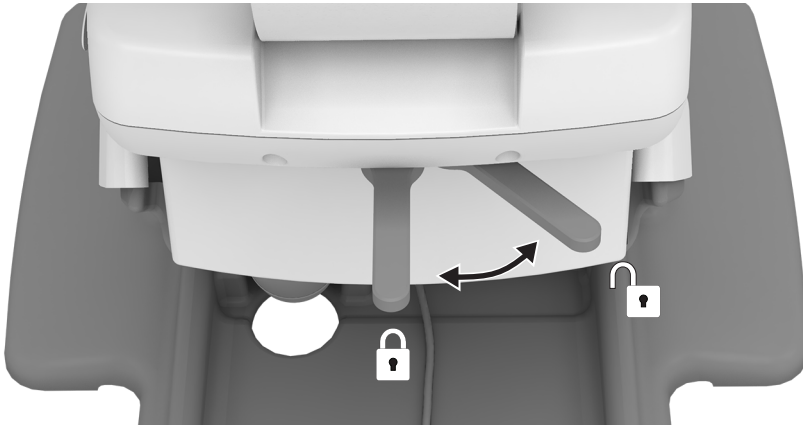

The chair can rotate to any position within 30° either side of center. The chair swivel brake restricts rotation of the chair to keep the chair from moving during a procedure.

To release the swivel brake, pull the brake lever to the right. To engage the brake, pull the brake lever firmly to the left.

## Adjust the Chair Swivel Brake Tension

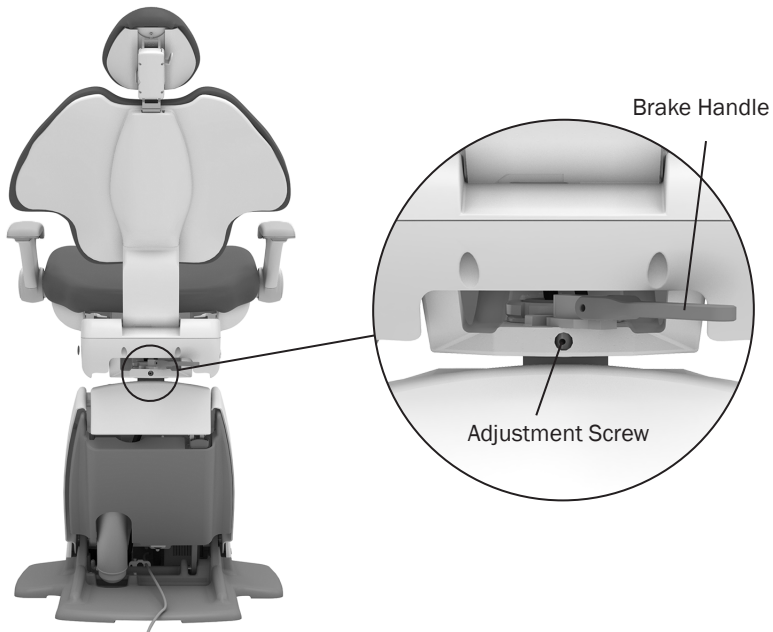

If the chair swivels left or right with the brake engaged, or is difficult to move with the brake disengaged, adjust the swivel brake tension. Properly tensioned, the brake handle should be in the middle when it is fully engaged. To make the adjustment:

1. Move the brake handle to the right.
2. If the chair includes a back mount module, swivel the chair to access the adjustment screw.
3. Use a 7/64" hex key and turn the tension adjustment screw clockwise to increase brake friction or counterclockwise to decrease brake friction. Only a small adjustment is needed to significantly increase or decrease tension.

# Clean / Maintain Dental Chair

## Protect with Barriers

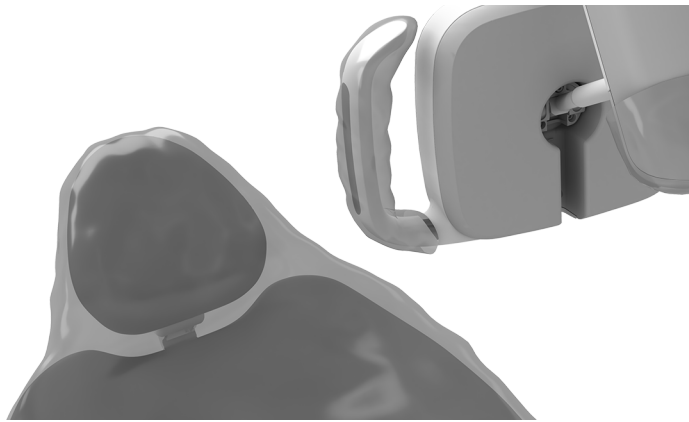

**NOTE** For proper use and disposal of barriers, see the instructions provided by the barrier manufacturer.

A-dec recommends barrier protection for all applicable touch and transfer surfaces. Touch surfaces are areas that come into contact with hands and become potential cross-contamination points during dental procedures. Transfer surfaces are areas that come into contact with instruments and other inanimate objects.

In the USA, barriers must be produced under the Current Good Manufacturing Practice (CGMP) as specified by the U.S. Food and Drug Administration (USFDA). For regions outside the USA, refer to the medical device regulations specific to your location.



**IMPORTANT** For recommendations on cleaning and chemical disinfection of touch and transfer surfaces (where barrier protection is not applicable or when barriers are compromised), please see the *A-dec Equipment Asepsis Guide* (p/n 85.0696.00).

## Extend the Life of the Upholstery



**CAUTION** Do not use household bleach (sodium hypochlorite) or other products containing chlorine, isopropyl alcohol (greater than 25 percent by volume), or hydrogen peroxide to clean or disinfect the upholstery. It can cause rapid deterioration and damage the product.

To preserve the quality of your A-dec upholstery, use barrier covers instead of relying on chemicals. Barriers significantly extend the life of the upholstery and will help preserve its luxurious look and soft feel. To clean the upholstery, use a solution of mild dishwashing liquid and water. Use surface disinfectants only when the barriers have been compromised or there is visible spatter on the upholstery. For more information, see the *Upholstery Maintenance Guide* (p/n 86.0501.00) available in the Resource Center at [www.a-dec.com](http://www.a-dec.com).

## Access the Utilities

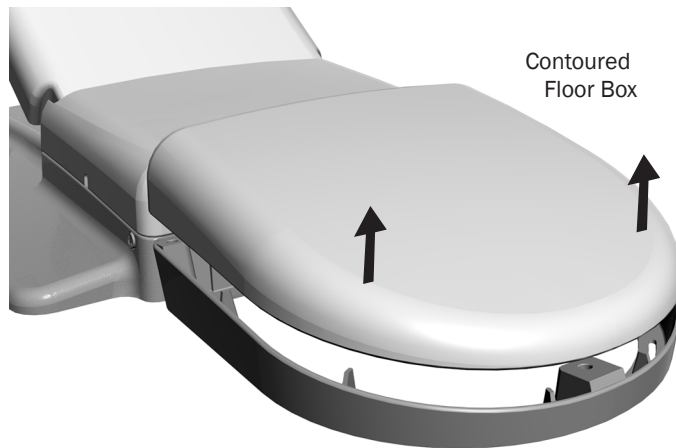

**CAUTION** When removing or replacing covers, take care not to damage any wiring or tubing. Verify that the covers are secure after replacing them.

The chair utilities are located in the contoured floor box under your chair and typically include the electrical outlet, as well as the system hookups for air, water, and vacuum. To access, lift the cover up and off the floor box frame. For maintenance, contact your local authorized A-dec dealer.

# Delivery Systems/Assistant's Instrumentation

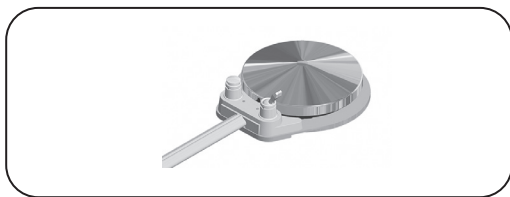
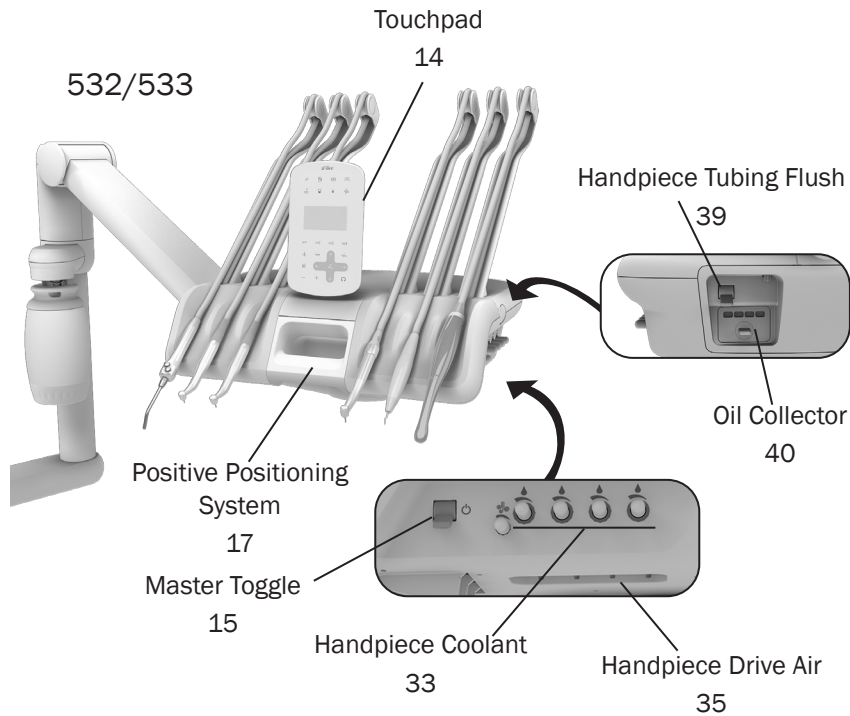

Foot Control  
20

Operate / Adjust .....	15
Clean / Maintain.....	39
Specifications .....	62

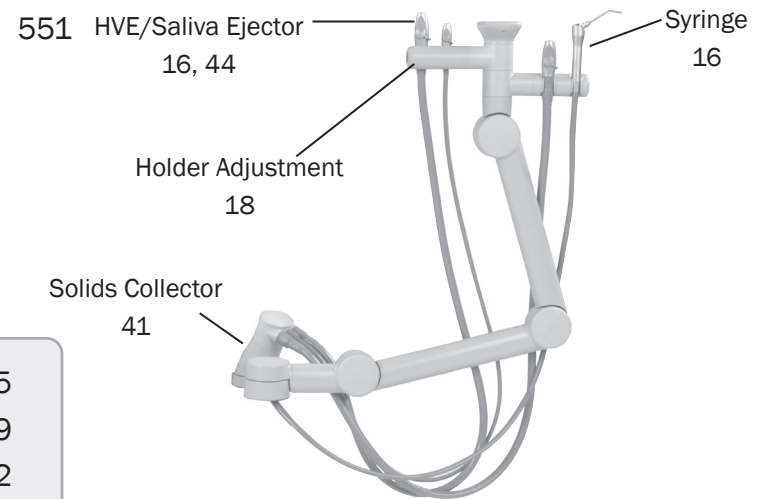
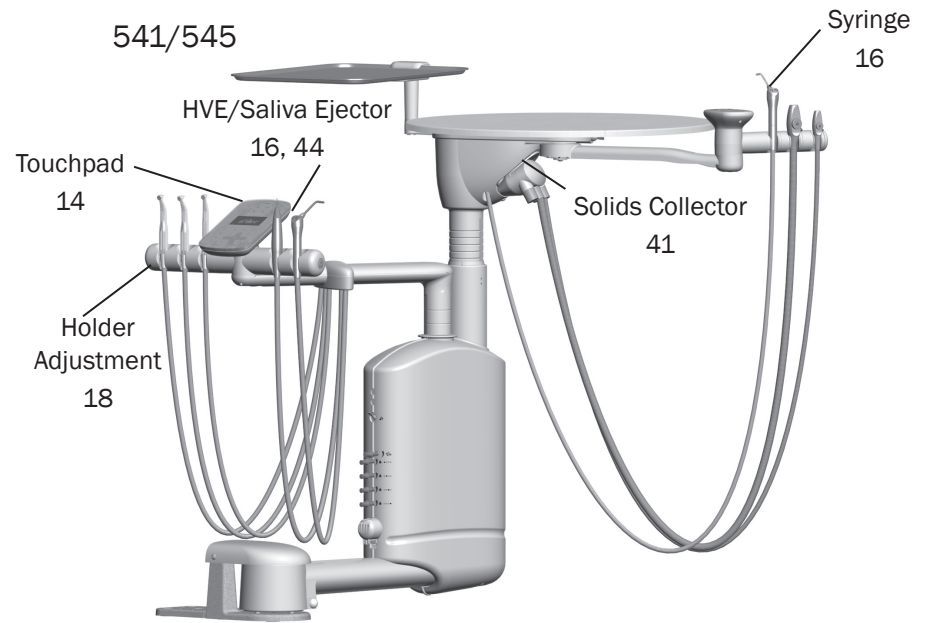

## Deluxe Plus Touchpad Content Map



Icon	Function	Page
a1	Auxiliary Device .....	21
	Touchpad Lockout .....	21
	Dental Light .....	24
	A/B User .....	21
	Cuspidor Bowl Rinse and Cupfill .....	25
	Water and Air Coolant On/Off .....	26
m1 – m4	Instrument Memory Presets .....	27
	Chair Manual Controls .....	22
	Chair Presets .....	23
	Program Mode.....	23
	Handpiece Mode .....	26
– +	Decrease/Increase/Selection Controls .....	27
	Motor Forward/Reverse .....	30

Note: Touchpad icons and symbols are proprietary to A-dec Inc.

# Operate / Adjust Delivery Systems

## Turn On/Turn Off the Air, Water, and Power

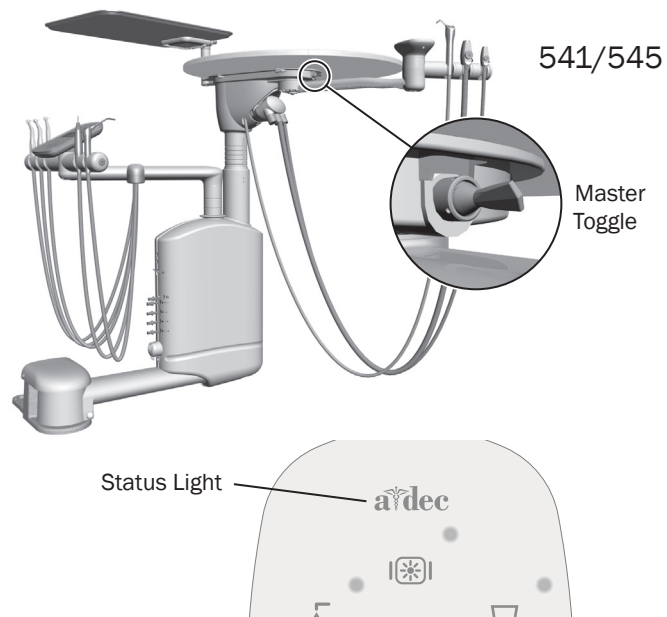
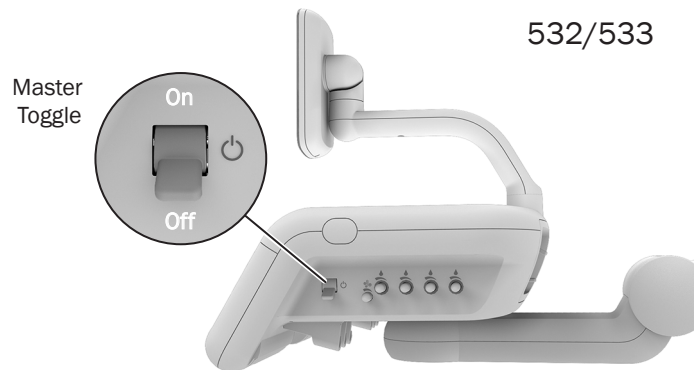

**NOTE** A-dec recommends that you perform a shock treatment on the dental unit waterlines before you use the system for the first time. For more information, see “Waterline Maintenance” on page 28.

### Master Toggle

Use the master toggle to turn on the system air, water, and power. If there is no power to the system, verify that the power button on the chair is pressed in. This button must be on in order for the master toggle to control system power.

### When to Turn Off the Power

To save energy and reduce the chance of air leaks, press the power button to turn off power at the end of the day and before longer periods of non-use.

### Touchpad and the Status Light

The A-dec logo on the assistant’s touchpad illuminates when the system is on and ready for use. If the status light blinks, it may indicate that something is lodged under the chair. Remove the object to continue chair operation.

## Operate the Autoclavable Syringe

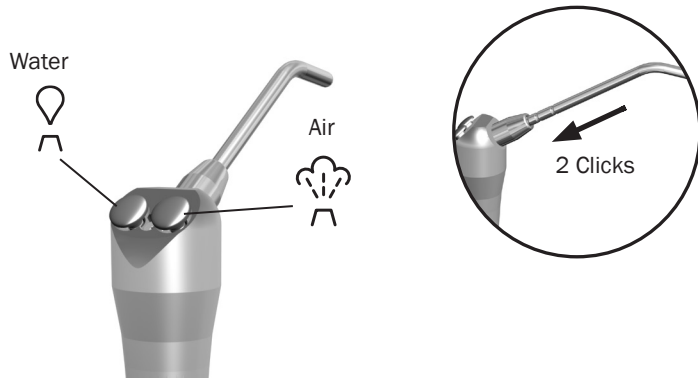

To install the A-dec syringe tip, push the tip in until you feel two clicks. Press both buttons simultaneously for the air/water spray.



**IMPORTANT** For more details on syringe usage and maintenance, see your A-dec syringe Instructions for Use.

## HVE/Saliva Ejector Left/Right Conversion 541/545/551

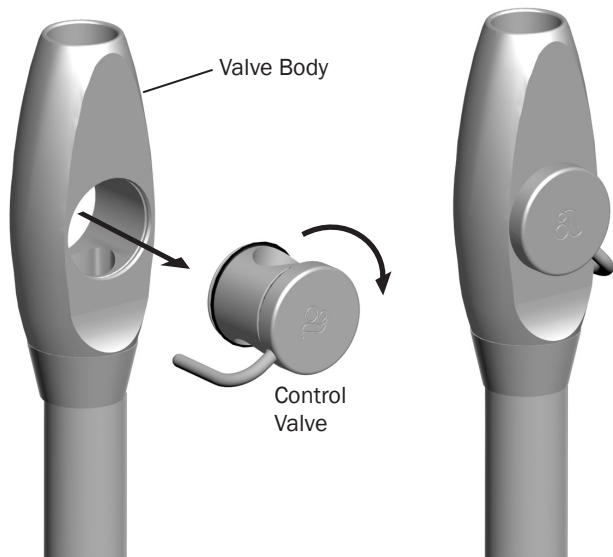

To convert the standard high-volume evacuator (HVE) and saliva ejector for left-handed operation, push the control valve out of the valve body, rotate the control valve 180°, and push it back into place.



**NOTE** Be sure to reinstall the valve on the same side of the valve body. Otherwise, the HVE or saliva ejector will not operate properly.



## Position the Delivery System 532/533

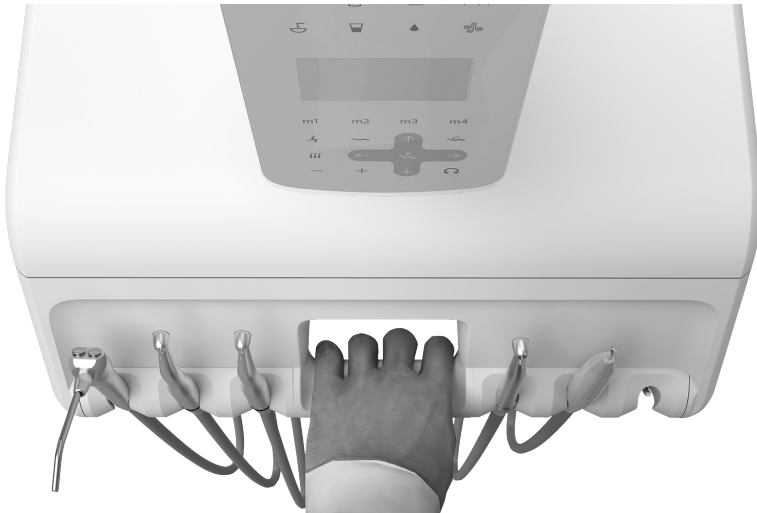

**NOTE** You can place up to 4 pounds (1.8 kg) on top of the system or optional tray holder.

The positive positioning system holds the delivery system in place until you grasp the handle. A sensor detects your grip and releases the brake. To position the system:

1. Grasp the handle.
2. Move the system to the desired location.
3. Release the handle to re-engage the brake.

## Position the Handpiece Holders 532/533

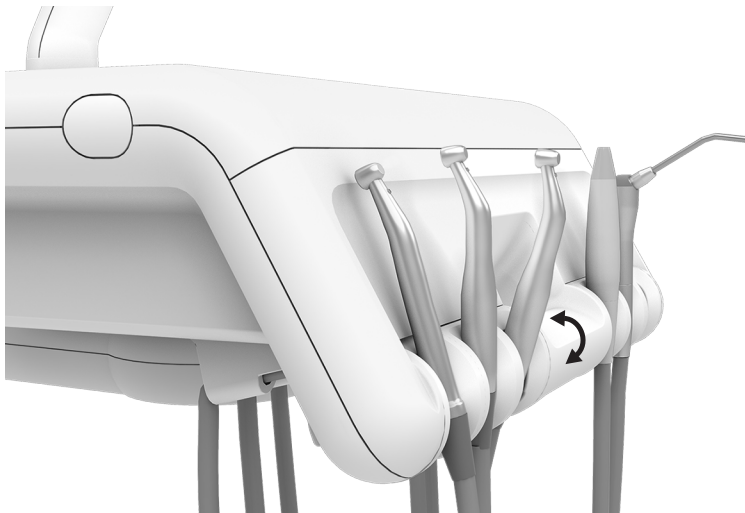

**CAUTION** Do not use a handpiece or other clinical device to adjust the holder or you may damage that device.

On 532 Traditional delivery systems, you can independently adjust each handpiece holder. Use your hand (or A-dec syringe as leverage) to adjust the holder until you achieve the desired angle.

## Position the Handpiece Holders 541/545/551

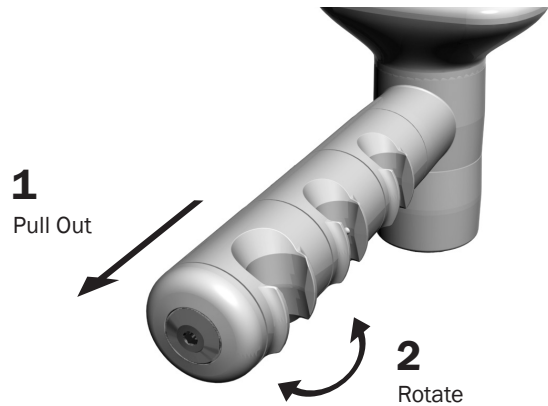

**CAUTION** Twisting the holder without pulling it away from the adjacent one will damage the mechanism.

You can adjust the instrument holders independently or as a set (on the doctor's side and the assistant's side).

1. Pull the holder, or holders, away from the touchpad/handle.
2. Rotate to the desired position and release.

## Adjust the Worksurface and Instrumentation Height 541/545

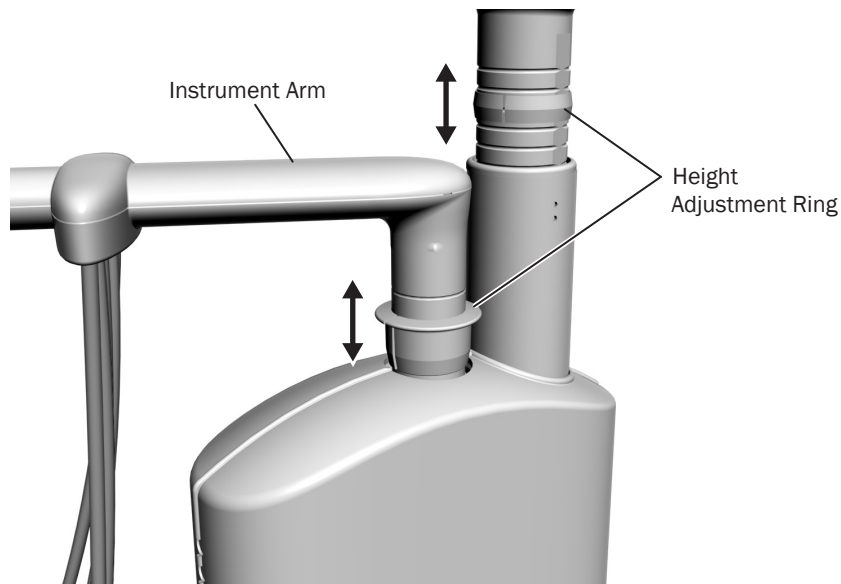

To adjust the height of the worksurface and the instrumentation arm:

1. Lift up the instrument arm or worksurface.
2. Slide the adjustment ring to the desired position.
3. Lower the instrument arm or worksurface post until the ring is securely seated.

## Auto-Electric Holders 551

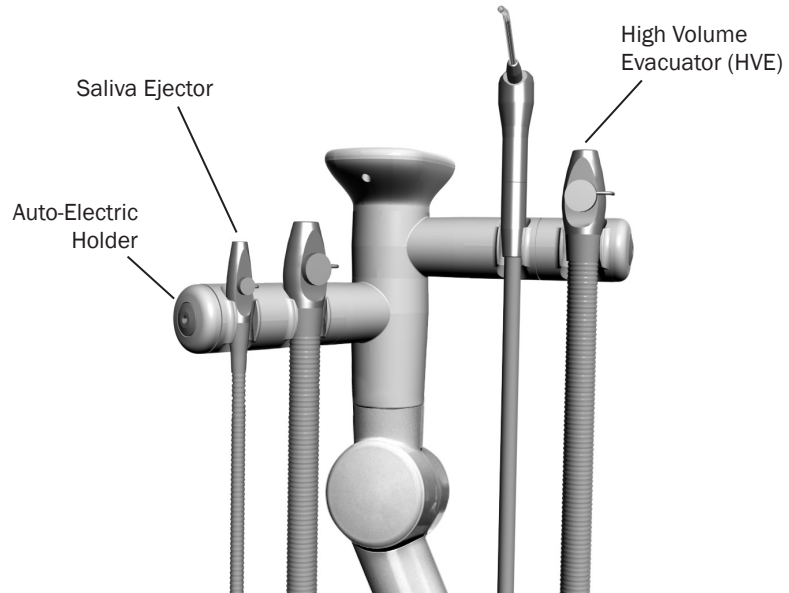

If you have a chair-side vacuum system and auto-electric holders, lift the HVE or saliva ejector from its holder and open the valve to turn on the vacuum. Return the instrument to its holder to turn off the vacuum.

## Operate the Foot Control

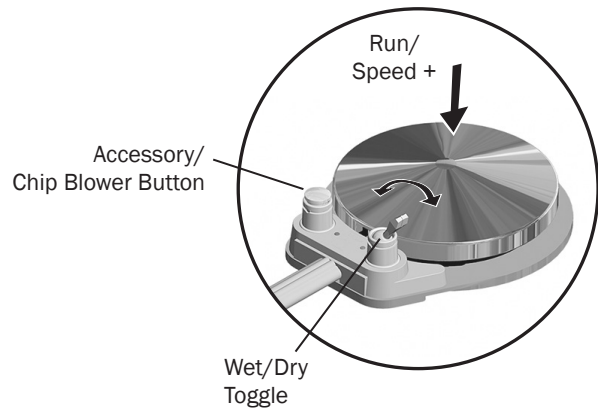





To activate a handpiece, lift it from the holder or pull the whip forward. Use the foot control to perform the desired handpiece operation.

Control	Operation	Procedure
<b>Disc Foot Control</b>	Run a handpiece.	Press on the disc. Push down to increase speed.
	Run a handpiece with or without water coolant.	Press  on the touchpad to turn the coolant on or off, or flip the wet/dry toggle (which works as a three-way switch in conjunction with the touchpad). Then press on the disc.
	Run the optional accessory/chip blower.	Press the accessory/chip blower button.*
	Operate the intraoral camera.	Press on the disc to capture an image.*

\* Contact your authorized A-dec dealer for questions about the operation or configuration of your integrated A-dec sanctioned clinical devices.

## Operate Touchpad Lockout, User Setting, and Auxiliary Device Control



Icon/Function	Actions/Options
 <b>Touchpad Lockout</b>	Press and hold  to activate the touchpad lockout, which allows you to barrier protect and clean/disinfect the touchpad without unintentionally activating any commands. A small light above the icon flashes while the touchpad is locked for 15 seconds.
 <b>A/B User</b>	Two sets of customizable settings (A and B) are available. To select a different user setting, press  . The selected user setting is indicated by the A or B in the lower left corner of the touchpad display.
<b>a1</b> <b>Auxiliary Device On/Off</b>	If your system includes an A-dec relay module and a connected device, press <b>a1</b> to turn on or turn off that device. A small light above the icon illuminates when the device is on.
 <b>NOTE</b>	If two operators use the delivery system, be sure to select the correct user setting (A or B) before changing any memory settings. The selected set is indicated by the A or B in the lower-left corner of the touchpad display.

## Position the Chair with Manual Controls

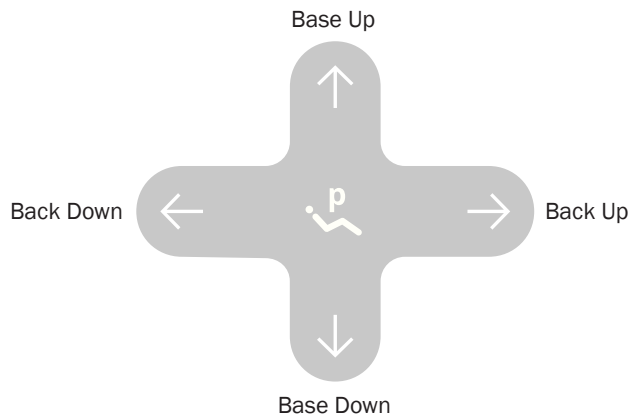
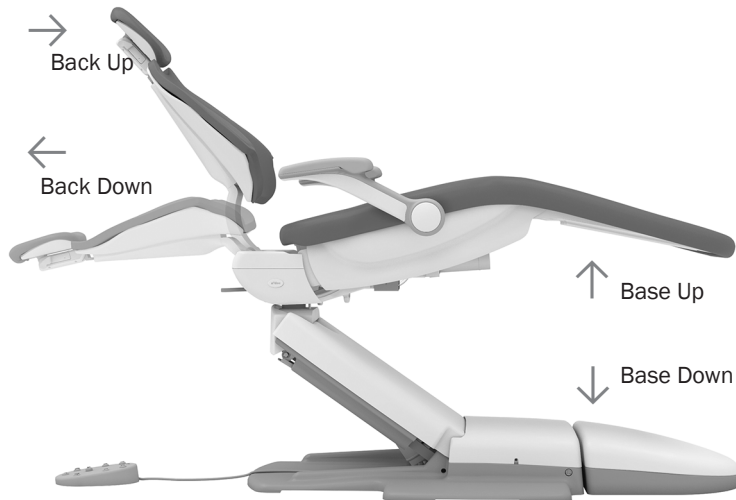

**IMPORTANT** The A-dec touchpad and footswitch move the chair in the same manner. For more details about footswitch controls, see your chair Instructions for Use.



**WARNING** Ensure that the patient is positioned safely before using the manual or preset chair controls. Never leave the patient unattended while the chair is in motion. Always take extra care with small children and patients with limited mobility.

To stop the chair at any point during preset movement, press any chair positioning button on the footswitch or touchpad.



**NOTE** If you would like to adjust the maximum height of your chair, contact your local authorized A-dec dealer.

Icon/Function	Actions/Options
↑ Base Up	Press and hold ↑ to raise the chair base.
↓ Base Down	Press and hold ↓ to lower the chair base.
→ Back Up	Press and hold → to raise the chair back.
← Back Down	Press and hold ← to lower the chair back.

## Position the Chair with Preset Controls

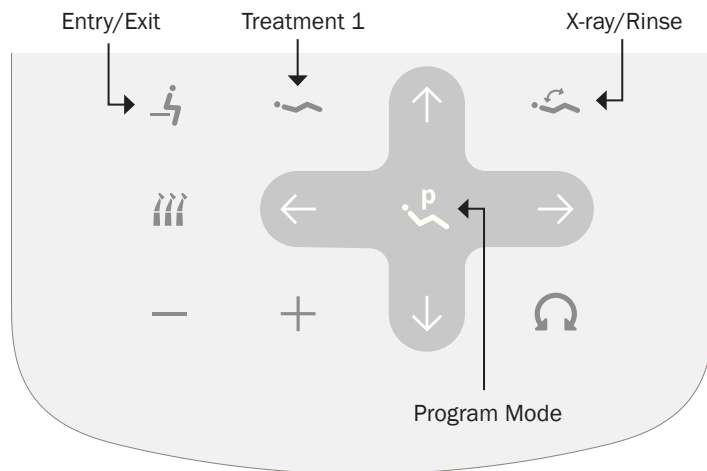

### Standard Touchpad

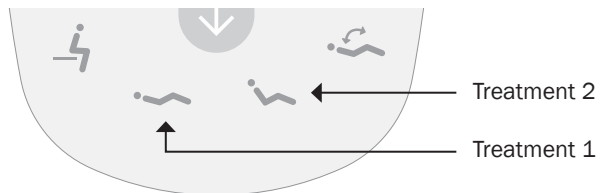

Icon	Preset Name	Factory Setting
	Entry/Exit	Positions the chair for patient entry/exit.
	Treatment 1	Positions the chair base and back down.
	Treatment 2	Positions the chair base down and the back partially up.
	X-Ray/Rinse	Moves the chair to either x-ray or rinse position. A second press moves the chair to the previous position.

Press , , or (also on the standard touchpad) to move the chair to a preset position. See the table (below left) for factory settings.

### Customize the Chair Preset Positions

To customize chair presets , , and :

1. Position the chair as desired.
2. Press and hold until you hear one beep, which indicates program mode is on.
3. Within five seconds, press the chair preset you wish to change (for example, press ). Three beeps confirm that your new setting is saved.

### Customize the X-Ray/Rinse Chair Preset

The factory preset moves the chair and patient into an upright position for x-rays or cuspidor access. A second press of returns the chair to the previous position.

You can also set to function as a customized chair preset position. To change its function:

1. Press and at the same time and hold for three seconds.
  - One beep indicates is set as another customizable chair preset.
  - Three beeps indicate that is set as the x-ray/rinse factory preset (which toggles between the x-ray/rinse position and the previous chair position).
2. If you set as another customizable chair preset and want to assign a different chair position, follow the steps outlined above in “Customize the Chair Preset Positions.”

## Operate the Dental Light

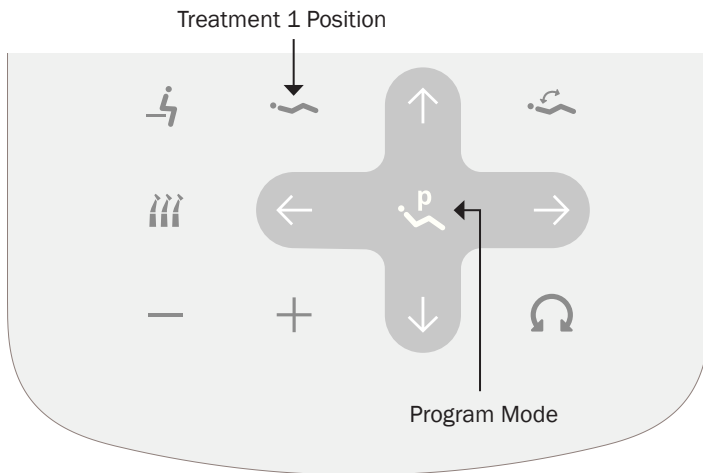
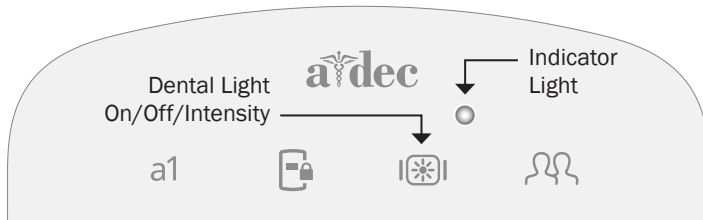

### Standard Touchpad

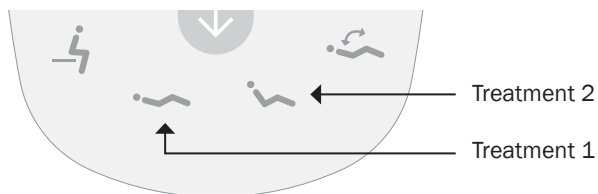

### Turn On/Turn Off the Dental Light and Change the Intensity

- To turn on the light, press .
- To change the light intensity mode, press . The indicator light flashes continuously in cure-safe and composite/low modes.
- To turn the light off, press and hold .

### Set the Dental Light Auto On/Off Function

When you press (also on the standard touchpad), the dental light automatically turns on once chair motion stops. The light turns off when you press or .

To disable or enable this function, press and hold and at the same time.

- One beep indicates the function is off.
- Three beeps indicate the dental light auto on/off function is on.



**IMPORTANT** For more details on dental light operation, see your dental light Instructions for Use.



## Operate the Cuspidor



### Turn On/Turn Off Cupfill and Bowl Rinse

Use the icons on the touchpad (☒, ☒), or the buttons on the cuspidor (☒, ☒) to control cupfill and bowl rinse functions.

Icon/Function	Actions/Options
☒ (or ☒) Cupfill	<ul style="list-style-type: none"> <li>Press once for a timed operation. The factory preset is a 2.5 second fill.</li> <li>Press and hold for manual operation.</li> </ul>
☒ (or ☒) Bowl Rinse	<ul style="list-style-type: none"> <li>Press once for a timed operation. The factory preset is a 30 second rinse.</li> <li>Press twice for continuous flow. Then press once to stop the flow.</li> <li>Press and hold for manual operation. Release to stop the flow.</li> </ul>

### Customize Cupfill and Bowl Rinse Timing on the Touchpad

1. Press and hold ☒ until you hear one beep, which indicates program mode is on.
2. Within five seconds, press and hold ☒ or ☒ for the desired time.
3. Three beeps confirm that your new settings are saved.

### Customize Cupfill and Bowl Rinse Timing on the Cuspidor





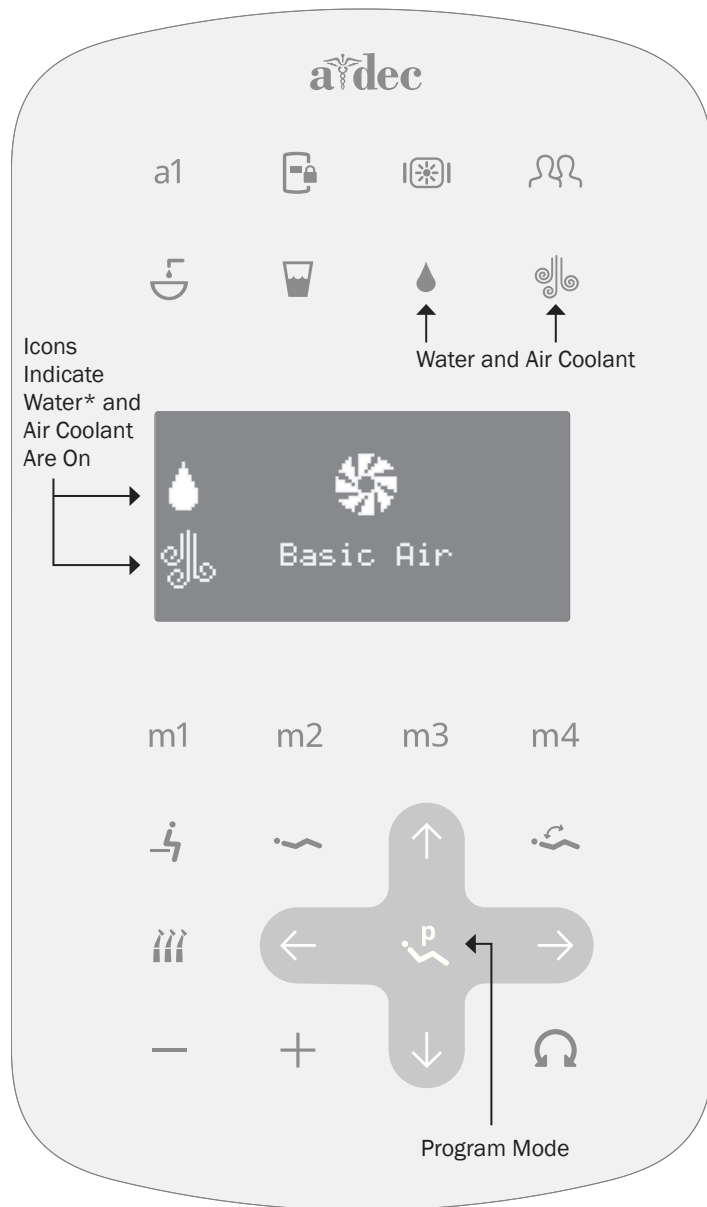



1. Press and hold ☒ and ☒ under the cupfill spout until you hear one beep, which indicates program mode is on.
2. Within five seconds, press and hold ☒ or ☒ for the desired time.
3. Three beeps confirm that your new settings are saved.

## Operate Basic Handpiece Controls



### Activate the Air and Water Coolant

To see and change basic air handpiece functions on the touchpad, lift the handpiece from the holder or pull the whip forward. Basic air appears on the display screen any time a standard air-driven high- or low-speed handpiece is detected.

Icon/Function	Actions/Options
 <b>Water Coolant On/Off*</b>	Press  . The icon appears on the left side of the screen when the water coolant is on.
 <b>Air Coolant On/Off</b>	Press  . The icon appears on the left side of the screen when the air coolant is on.
 <b>Euro Mode* On/Off</b>	<p>Euro mode allows you to turn on or turn off water and air coolant functions at the same time with one press of either icon.</p> <p>Press and hold  and  (or  and ) for three seconds. Three beeps indicate that the Euro mode is on. One beep indicates that it is off.</p>

## Operate Electric Handpiece Functions

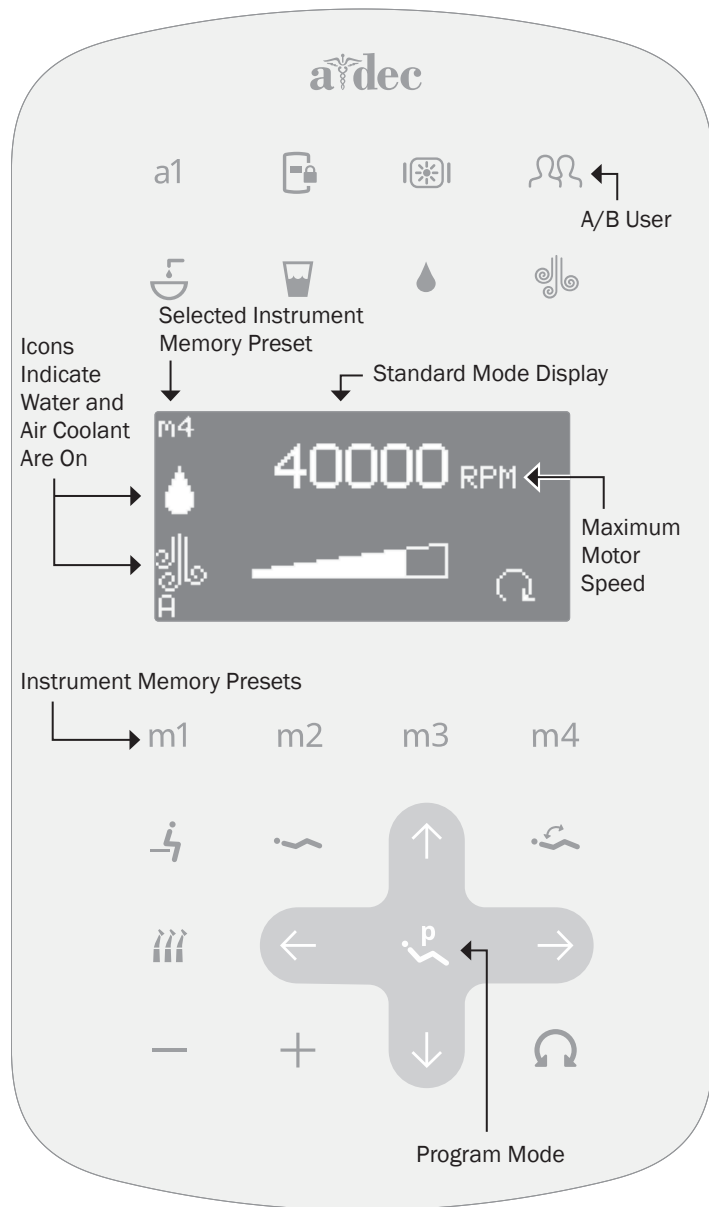

### Standard Mode Memory Presets

To activate the electric handpiece, lift it from the holder or pull the whip forward. The touchpad screen displays the previous settings used for that handpiece position. Use the memory presets to control motor speed and air/water coolant. Standard mode provides four factory presets with the following values:

Memory Preset	Maximum Motor Speed	Air Coolant	Water Coolant
m1	2,000 rpm	On	On
m2	10,000 rpm	On	On
m3	20,000 rpm	On	On
m4	40,000 rpm	On	On

### Customize the Standard Mode Memory Presets

You can customize the memory presets with your own specific values. In standard mode, each A/B user setting provides four memory presets for each handpiece. The endodontics mode offers an additional four presets per handpiece for each A/B user setting.

To change a preset:

1. Press  $-$  or  $+$  to change your preferred maximum motor speed.
2. Press  $\text{💧}$  and  $\text{🌀}$  to turn on/turn off water or air coolant.
3. Press and hold  $\text{P}$  until you hear one beep, which indicates program mode is on.
4. Within five seconds, press m1, m2, m3, or m4 to save the settings under your preferred memory preset. Three beeps confirm that your new settings are saved.

## Operate Electric Handpiece Functions *(continued)*

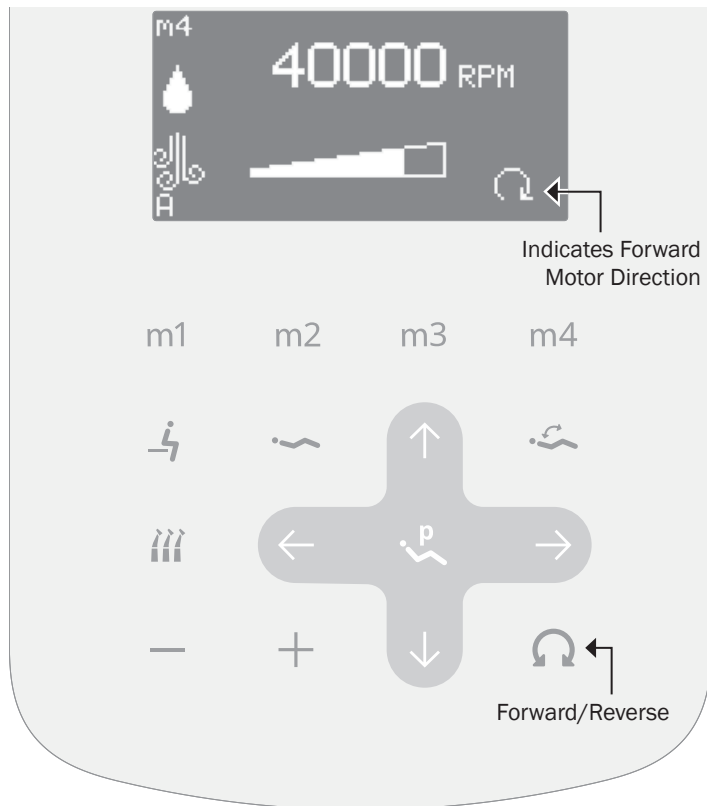

### Change the Motor Direction

Press  to change the motor direction. In reverse mode, the screen icon flashes continuously. Forward/reverse cannot be saved as part of the standard mode settings. The direction defaults to forward after you return the handpiece to its holder or turn off the system.



**NOTE** You can also use the foot control to switch between forward and reverse. When the motor has stopped, tap the accessory/chip blower button to change the direction. For more information, see page 20.

## Operate Electric Handpiece Functions *(continued)*

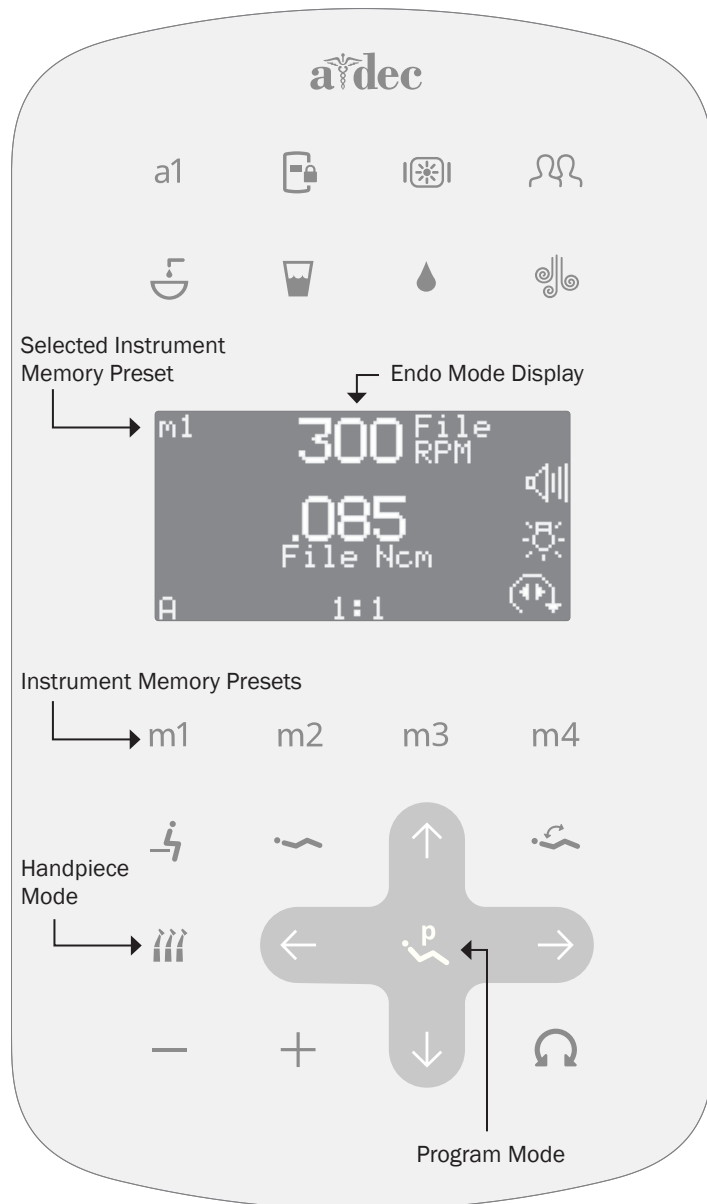



### Customize the Endodontics (Endo) Mode Memory Presets

The endo mode allows you to change a number of settings based on the specific file and desired handpiece behavior. Icons on the touchpad display screen reflect the settings.



**NOTE** For more information regarding speed and torque limits for a specific file, consult the file manufacturer.

To customize the endo mode settings:

1. Lift the handpiece from the holder or pull the whip forward.
2. If the touchpad screen does not display the endo mode, press .
3. To change settings in endo mode, press  $-$  or  $+$ . A white reverse video box is displayed on the touchpad screen.
4. Press  $\uparrow$ ,  $\downarrow$ ,  $\leftarrow$ , or  $\rightarrow$  to move from setting to setting on the touchpad screen.
5. Press  $-$  or  $+$  to change the setting as desired.
6. Press and hold  until you hear one beep, which indicates program mode is on.
7. Within five seconds, press m1, m2, m3, or m4 to save the settings under your preferred memory preset. Three beeps confirm that your new settings are saved.

For more details on these settings, see “Additional Details for Endo Mode Settings” on page 30.

## Operate Electric Handpiece Functions *(continued)*

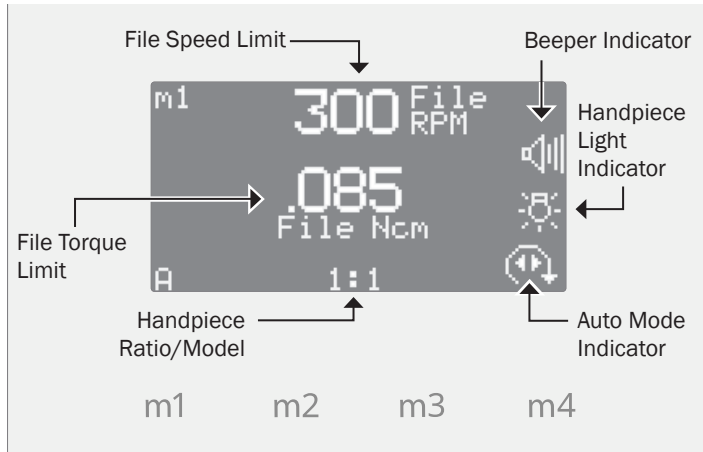

**WARNING** Endo file settings must be set according to the file manufacturer. File speed limits, torque limits, supported gear ratios, and supported auto modes should be provided in the endo file Instructions for Use. If these settings are not set properly, patient injury may occur. For more information, consult with your file manufacturer.



**\*NOTE** If the endo file gets stuck, the auto forward cycle repeats three times before the motor stops.

### Additional Details for Endo Mode Settings

Icon	Setting	Description
	Speed	Setpoint for the file speed limit. For more information, consult your file manufacturer.
	Torque	Setpoint for the file torque limit. For more information, consult your file manufacturer.
	Torque Units	Toggles between newton centimeters (N·cm) and gram centimeters (g·cm). When you change this setting, the change applies to all endo memory presets. <i>Note: 1 N·cm = 102 g·cm.</i>
	Ratio	Indicates the handpiece ratio or handpiece model. For more information, consult your handpiece manufacturer.
	Beeper	When active, the warning beep sounds when you approach torque limit and beeps twice when the file auto reverses. When you change this setting, the change applies to all endo memory presets.
	Handpiece Light	Indicates if the handpiece light is on in the endo mode.
	Auto Modes	The auto mode indicator is located inside the forward/reverse indicator. When you change this setting, the change applies to all endo memory presets.
	Auto Stop	<ul style="list-style-type: none"> <li>When the file reaches the torque limit, the motor shuts off.</li> </ul>
	Auto Reverse	<ul style="list-style-type: none"> <li>When the file reaches the torque limit, the motor stops and reverses direction until the foot control is released.</li> </ul>
	Auto Forward*	<ul style="list-style-type: none"> <li>When the file reaches the torque limit, the motor stops, reverses three turns, and then changes back to forward again.</li> </ul>

## Operate Ultrasonic Instrument Functions

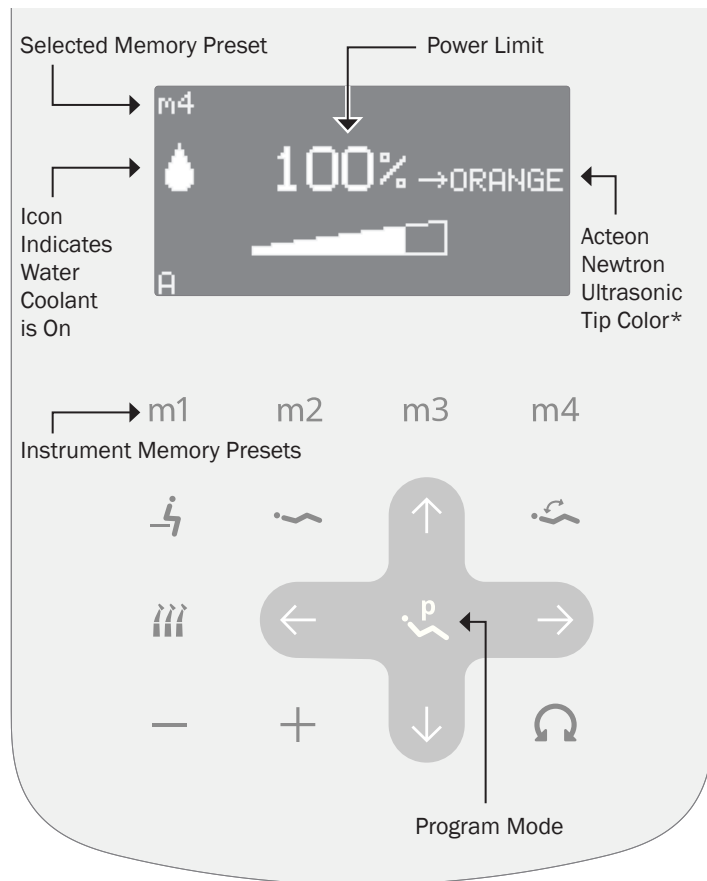

**\*NOTE** Tip color settings are only compatible with the Acteon Color Coding System™ and Newtron® tips. For more information, contact your local authorized A-dec dealer.



**NOTE** The A-dec foot control provides variable scaler output up to the maximum power limit on the display. Most tabletop devices operate differently and use on/off switching.

### Ultrasonic Memory Presets

To activate the device, lift it from the holder. The previous settings used for that handpiece position appear on the display screen. Standard mode provides four factory presets with the following values:

Memory Preset	Maximum Power Limit / Acteon Tip Color*	Water Coolant
m1	25% / Green	On
m2	50% / Yellow	On
m3	75% / Blue	On
m4	100% / Orange	On

### Customize the Ultrasonic Memory Presets

To customize an ultrasonic instrument preset:

1. Lift the instrument from the holder or pull the whip forward.
2. Press  $-$  or  $+$  to change the power limit percentage. With Acteon ultrasonic devices, the tip color changes automatically with power limit changes.
3. Press  $\text{💧}$  to turn on or turn off water coolant.
4. Press and hold  $\text{P}$  until you hear one beep, which indicates program mode is on.
5. Within five seconds, press m1, m2, m3, or m4 to save the settings under your preferred memory preset. Three beeps confirm that your new settings are saved.

## Touchpad Help Messages

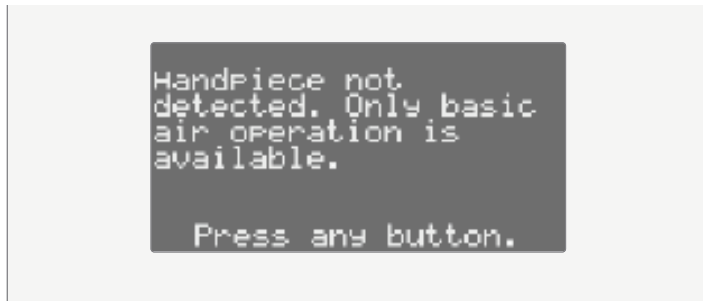

The touchpad displays help messages for disabled operations and other errors. When a help message appears, take note of the message, as well as the function you were performing, in case service is required.

For more details on help messages, see the *Regulatory Information, Specifications, and Warranty* document (p/n 86.0221.00), which is available in the Resource Center at [www.a-dec.com](http://www.a-dec.com).

## Other Handpiece and Accessory Settings

Contact your authorized A-dec dealer to change any of these handpiece and accessory settings, if applicable:

- **Auto-Off Delay** - determines how long the handpiece light remains on if the foot control is released. The default setting is 5 seconds.
- **On When Selected** - specifies whether the handpiece light turns on or remains off (until the foot control is pressed) when the handpiece is removed from the holder.
- **On in Endo** - specifies whether the handpiece light turns on or off when the endo mode is selected. The default setting is off.
- **Voltage Adjustment** - allows for customized light output voltage for each handpiece position. The default setting is 3.2 VDC.



## Adjust the Handpiece Coolant Spray

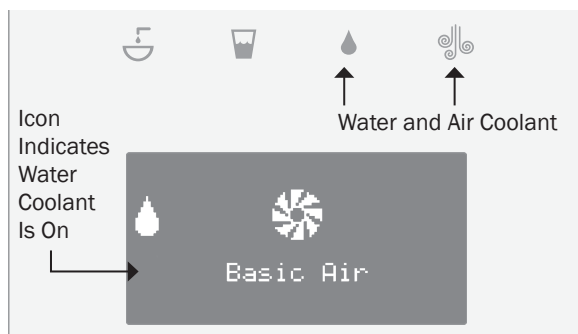
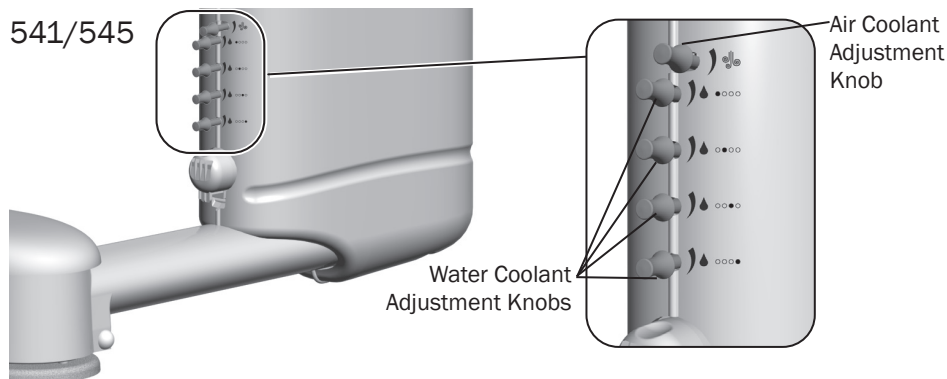
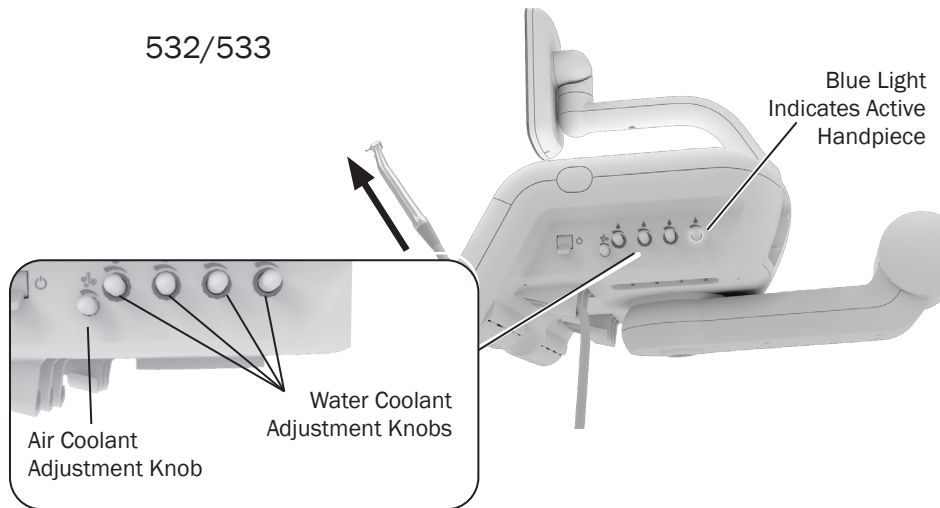

**CAUTION** When performing this procedure, do not attempt to completely shut off the water or air flow. The adjustment knobs are not designed to completely shut off flow and can damage the control block if you apply too much force.

The air coolant knob on your delivery system adjusts air flow to all handpiece positions simultaneously. Each water coolant knob adjusts water flow to a single handpiece position.

Use the following process to adjust for the desired handpiece coolant atomization:

1. Ensure that a bur is inserted into each handpiece you expect to adjust.
2. Lift the handpiece from the holder or pull the whip forward.
3. Press  on the touchpad to turn off the air coolant.
4. Do one of the following:
  - On systems with a disc foot control – use the touchpad or wet/dry toggle to turn on the water coolant, then press the disc all the way down.
  - On systems with a lever foot control – move the lever all the way to the left to run the handpiece at full speed with water.
5. Gently turn the water coolant adjustment knob (to the corresponding handpiece) clockwise until coolant flow stops. Then slowly turn the knob counterclockwise until water droplets are expelled from every water port on the handpiece head.
6. Release the foot control and return the handpiece to the holder.
7. Repeat steps 2 through 6 for each handpiece.

Continue with step 8 on page 34.

## Adjust the Handpiece Coolant Spray *(continued)*

532/533

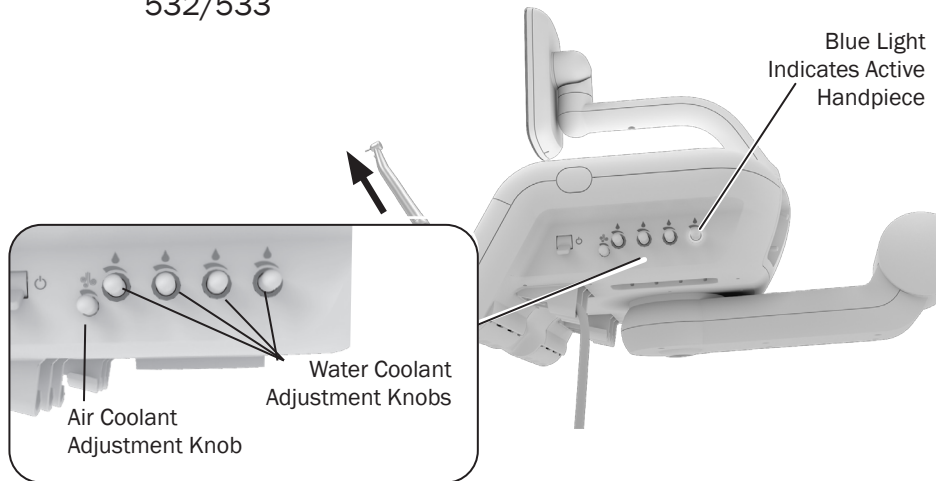

8. Lift the handpiece from the holder, or pull the whip forward, and press  on the touchpad to turn on the air coolant.
9. Fully press the foot control.
10. Locate the air coolant adjustment knob. Adjust the air coolant until you achieve the desired atomization at the cutting surface of the bur. Counterclockwise increases flow.



**CAUTION** Do not continue turning the air coolant adjustment knob counterclockwise after the air coolant stops increasing. The stem may come out of the control block.

11. Use the water coolant adjustment knob, as needed, to make any additional fine adjustments in water coolant output.
12. Repeat steps 8 through 11 for each handpiece.

541/545

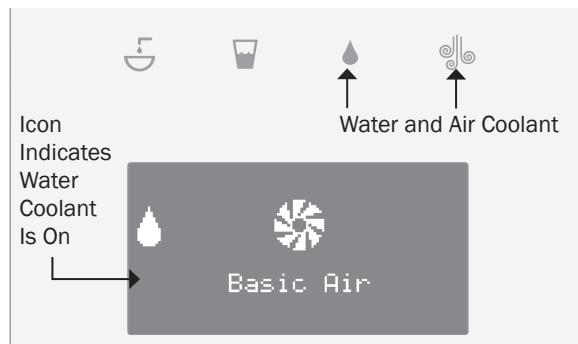
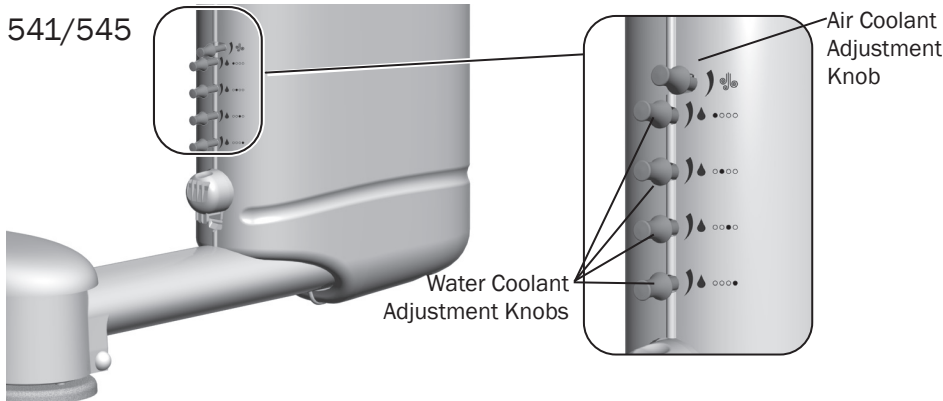

## Adjust Handpiece Drive Air Pressure

532/533

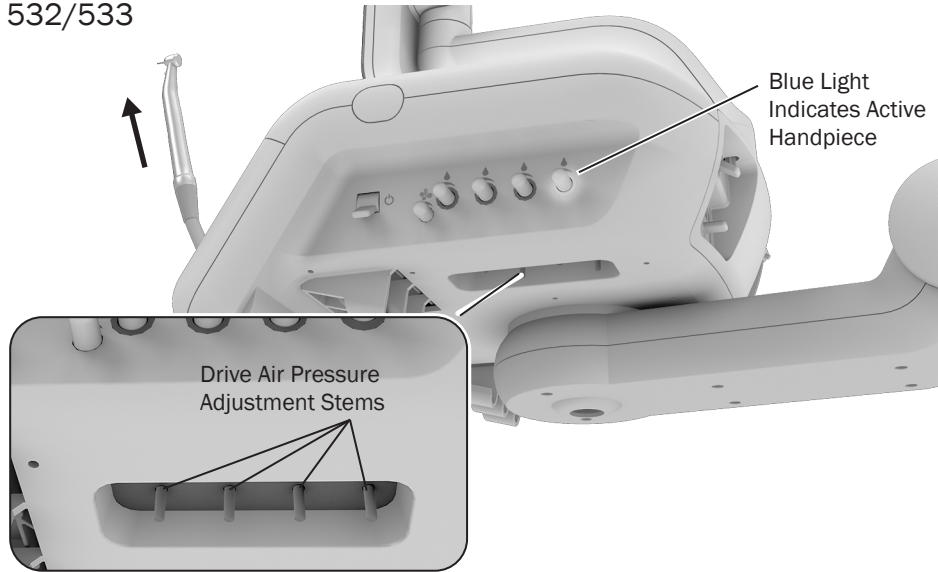

541/545

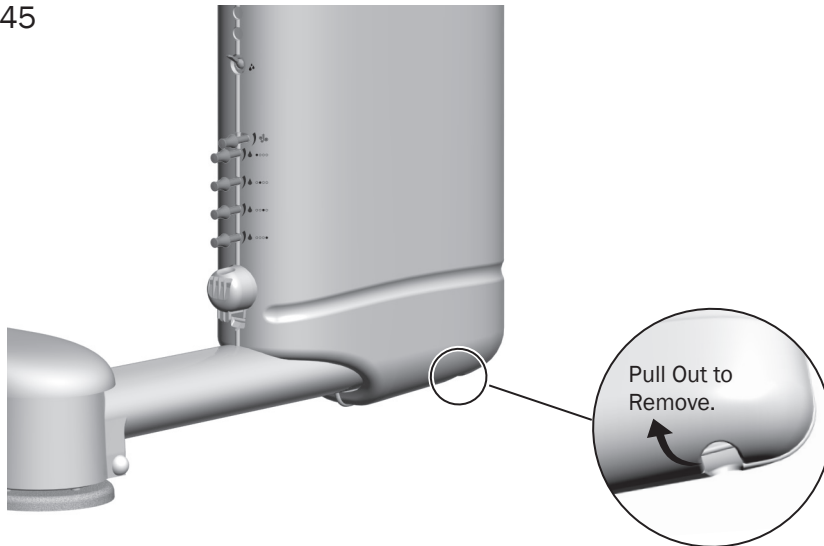

**CAUTION** Exceeding the manufacturer's recommended drive air pressure increases the risk of damage and may significantly decrease the life of your handpiece components. For the proper drive air pressure, see the handpiece manufacturer's Instructions for Use.



**NOTE** Drive air pressure varies throughout the system and can be more than 5 psi (34 kPa) lower at the handpiece than what is shown on the touchpad. To achieve the most accurate drive air measurement, use a handpiece pressure gauge attached to the handpiece tubing. To order a gauge, or for more information, contact your local authorized A-dec dealer.



**TIP** 532/533: When you lift the handpiece, or pull the whip forward, a blue light around the water coolant adjustment knob indicates which handpiece is active. Use the light to locate the corresponding drive air adjustment stem under the delivery system.



**CAUTION** When you remove or replace the cover, take care not to damage any wiring or tubing. Verify that the cover is secure after you replace it.

541/545: In order to adjust handpiece driver air, you must first remove the delivery system covers. Locate the hole directly under the delivery system and pull the covers apart. To replace, position the covers over the delivery system and snap together.

## Adjust Handpiece Drive Air Pressure *(continued)*

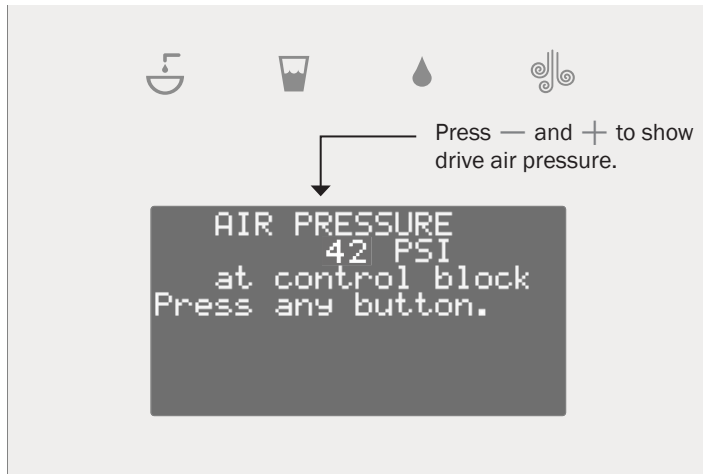

A handpiece must be attached to the tubing to read the pressure.

For systems with a **disc foot control**:

1. Lift the handpiece from the holder or pull the whip forward.
2. Use the touchpad or wet/dry toggle to turn off the water coolant.
3. Press — and + at the same time to show the drive air pressure on the touchpad.
4. Locate the drive air pressure adjustment stem (under the delivery system for 532/533) that corresponds with the active handpiece.
5. Fully press the foot control to run the handpiece and adjust the drive air pressure to meet the manufacturer's specifications.

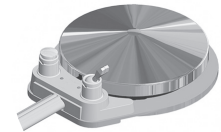

## Level the Control Head 532/533

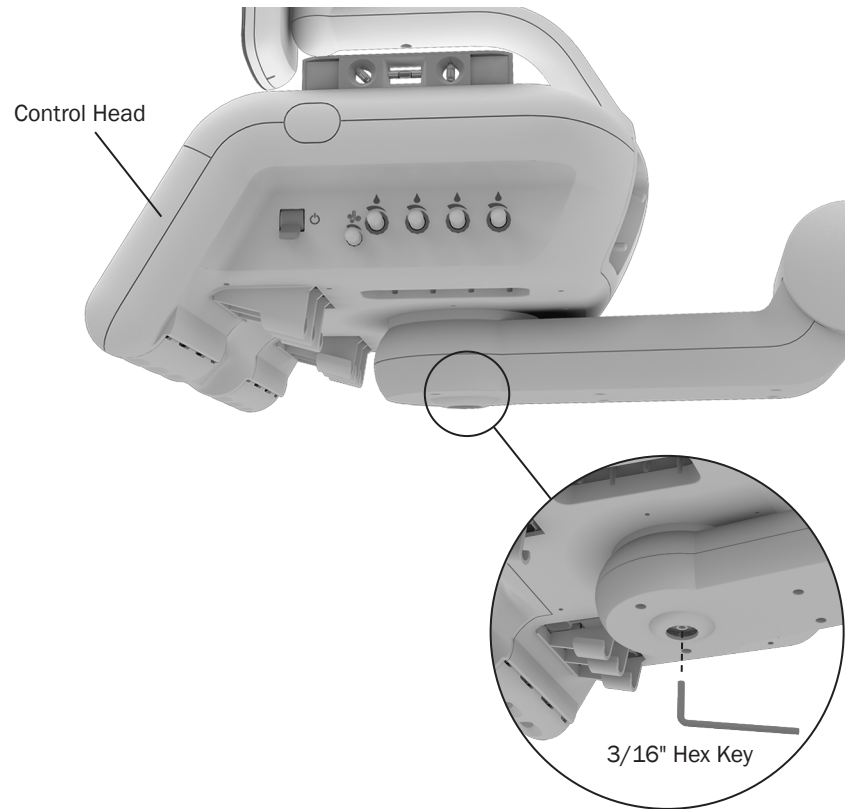

If the system is tilted front to back or side to side, level the control head.

1. Place the control head in its normal operating position, then raise the chair.
2. Place a level on top of the system.
3. Use a 3/16" hex key to loosen the adjustment screw just enough to move the control head.
4. Level the control head side to side and front to back.
5. Tighten the adjustment screw.

## Adjust the Tray Holder Mount Rotation Tension 532/533

If the tray holder mount is difficult to move, or too loose, use a 7/32" hex key to adjust the rotation tension. To make the adjustment easier on the upper tray holder, hold the post while you adjust the tension screw. Clockwise increases the tension.

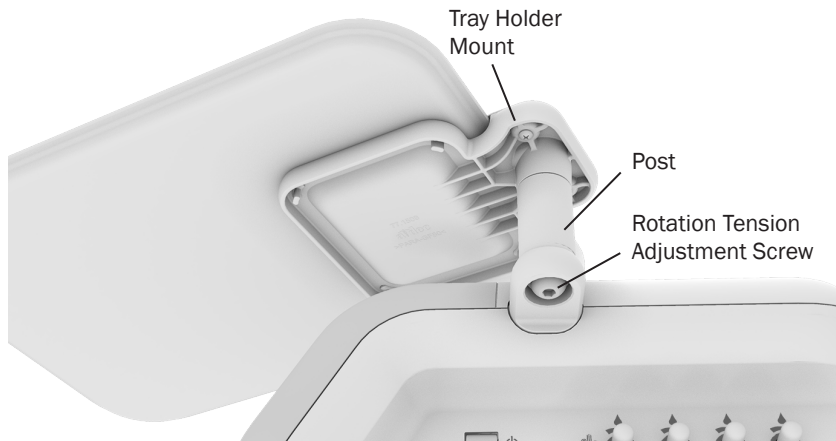

Upper Tray Holder Mount

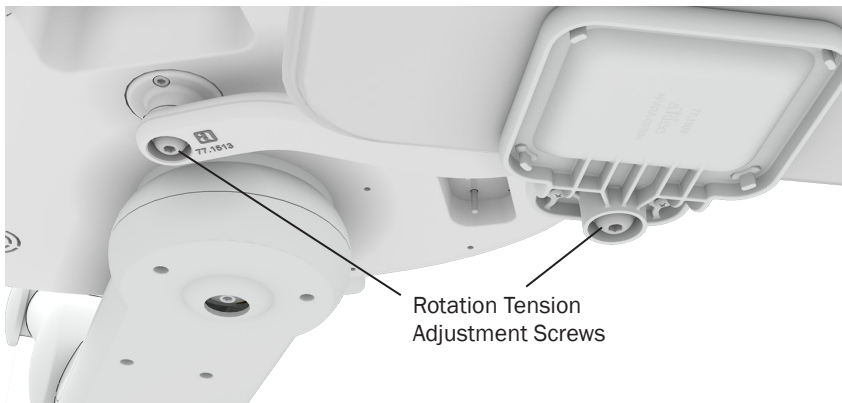

Lower Tray Holder Mount (Continental® Delivery Systems Only)

# Clean / Maintain Delivery Systems

## Flush the Handpiece Tubing

532/533

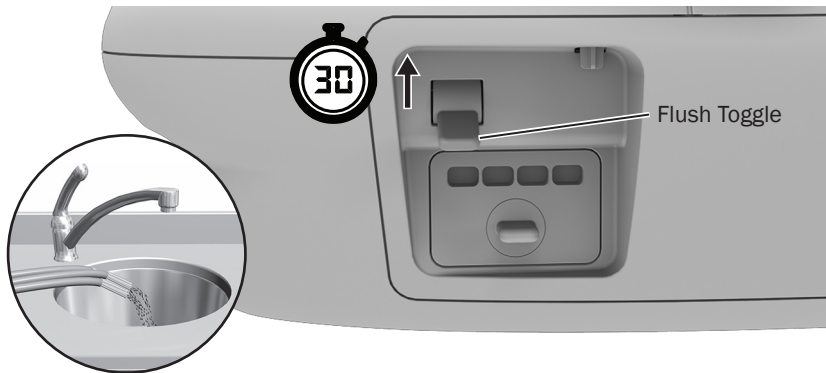

Use the flush toggle to move a high volume of water through the handpiece tubing. To flush the tubing:

1. Disconnect the handpieces.
2. Hold all of the handpiece tubing that uses water coolant over a sink, cuspidor bowl, or basin.
3. Flip the flush toggle up and hold for 20–30 seconds.



**NOTE** Flush all handpiece tubing (air and waterlines) in accordance with the regulations in your area. If no regulations exist, flush the tubing for a minimum of 20–30 seconds at the beginning of the day and after each patient.

541/545

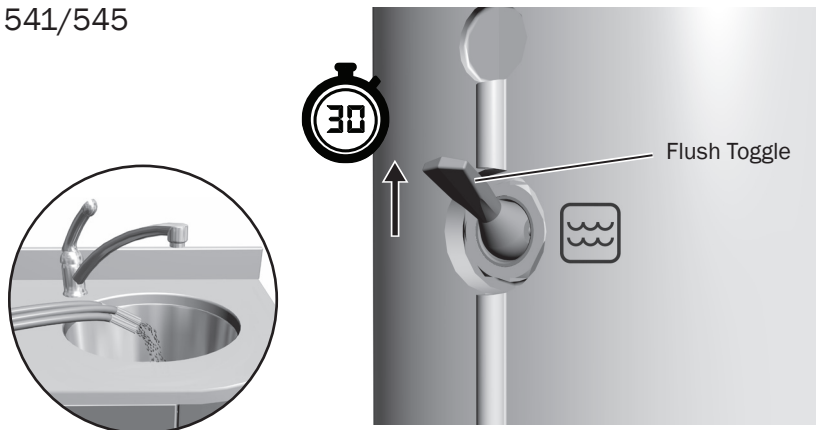

## Maintain the Oil Collector

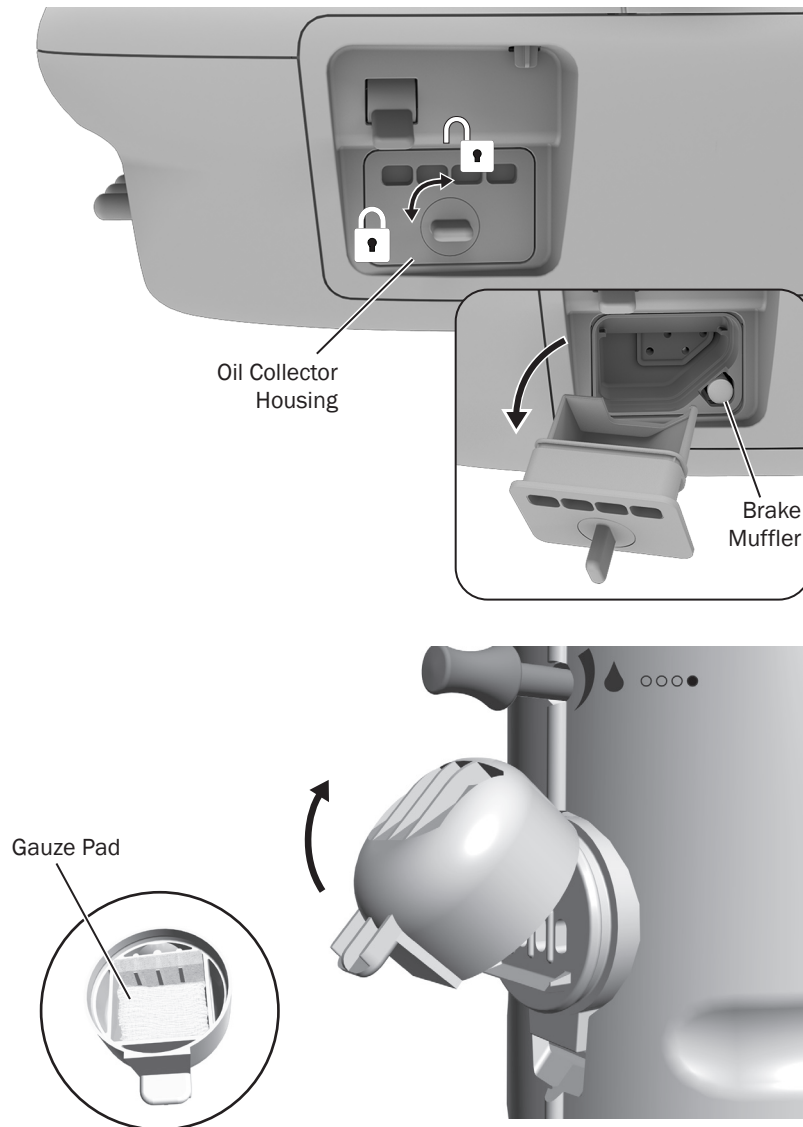

Service the oil collector on the delivery system once a week for normal use and more often for heavier use.

To service 532/533:

1. Turn the oil collector housing key clockwise to unlock, then pull out the housing from the control head.



**CAUTION** Take care not to grab the delivery system handle while the oil collector housing is removed. The cotton roll will eject if you activate the positive positioning system.

2. Remove and replace the old cotton gauze (use two 2" x 2" [51 mm x 51 mm] pads folded in half).



**NOTE** Do not replace the cotton roll in the right corner of the oil collector. This is a brake muffler that will rarely need replacement. For more information, see your local authorized A-dec dealer.

3. Reinsert the housing and turn the key counterclockwise to lock.

To service 541:

1. Unsnap the oil collector cover from the delivery system and discard the old gauze. Do not remove the foam muffler.
2. Fold a new gauze pad (2" x 2" [51 mm x 51 mm]) into quarters and place it inside the cover.
3. Snap the oil collector cover closed.



## Maintain Solids Collector 541/545/551

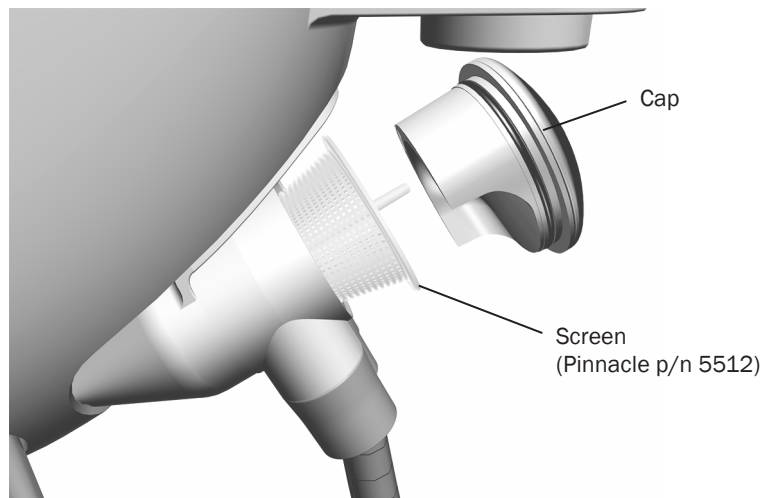

The solids collector helps prevent solids from entering the central vacuum system. To ensure proper suction from the central vacuum and maintain proper treatment room asepsis, discard and replace the solids collector screen at least twice a week.



**TIP** To obtain replacement solids collector screens, contact your authorized A-dec dealer and reference Pinnacle p/n 5512.



**DANGER** Infectious waste may be present. Follow asepsis protocol to prevent cross contamination.

To replace the solids collector screen:

1. Turn off the vacuum or open the HVE control valve.
2. Remove the solids collector cap.



**CAUTION** Do not empty the screen into your cuspidor. Doing so could plug the drain.

3. Remove the solids collector screen and discard according to your local regulations.



**NOTE** When you replace the solids collector cap, ensure that the keyed cutout faces down, or it will cut off the vacuum flow.

4. Insert a new screen in the solids collector and replace the cap.

## Utilities and Shutoff Valves

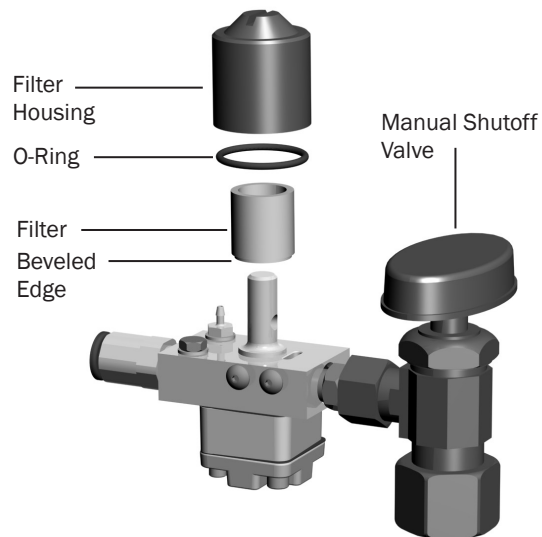
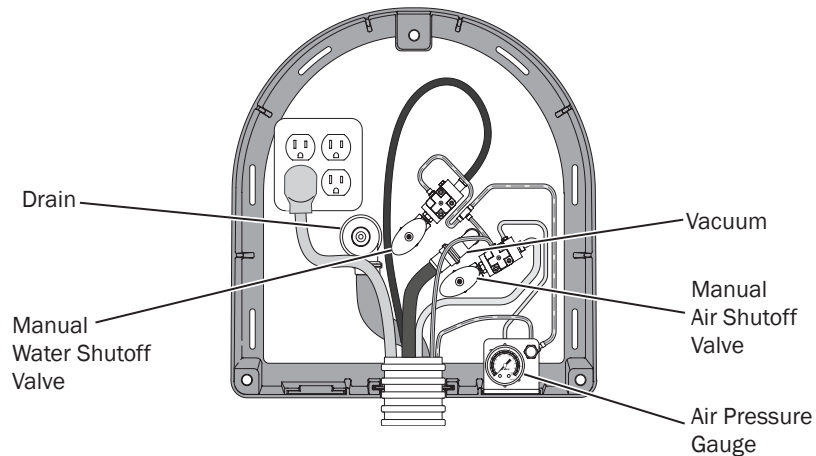

**CAUTION** To ensure proper operation, install the filter with the beveled edge facing the manifold.

The utilities are located in the contoured floor box for chair-mounted systems (A-dec 532/533). To access, lift up the floor box cover or removable cabinet panel.



**CAUTION** When removing or replacing covers, take care not to damage any wiring or tubing. Verify that the covers are secure after replacing them.

The manual shutoff valves control the air and water to the system. Leave these valves completely open (turned counterclockwise) during normal use to prevent leaks. From the valves, air and water pass through separate filters before entering the pre-regulators. Replace these filters when they become clogged and restrict flow.

To check for a clogged air or water filter:

1. Flip the master toggle to the on position.
2. While watching the air pressure gauge, press the syringe air button.
3. If the pressure drops by more than 15 psi, replace the air filter.
4. While watching the cuspidor, press the bowl rinse button. If the water flow fades or stops, replace the water filter.

To replace the filter:

1. Flip the master toggle to the off position and close the shutoff valve (turn clockwise).
2. Bleed the system of air and water pressure by operating the syringe buttons until air and water no longer flow.
3. Using a standard screwdriver, remove the filter housing from the water pre-regulator assembly and remove the filter.
4. Replace the filter if it is clogged or discolored. Install the filter with the beveled edge facing the manifold.
5. Open the shutoff valves, flip the master toggle to the on position, and operate the bowl rinse to remove air from the waterline.

## Utilities and Shutoff Valves *(continued)*

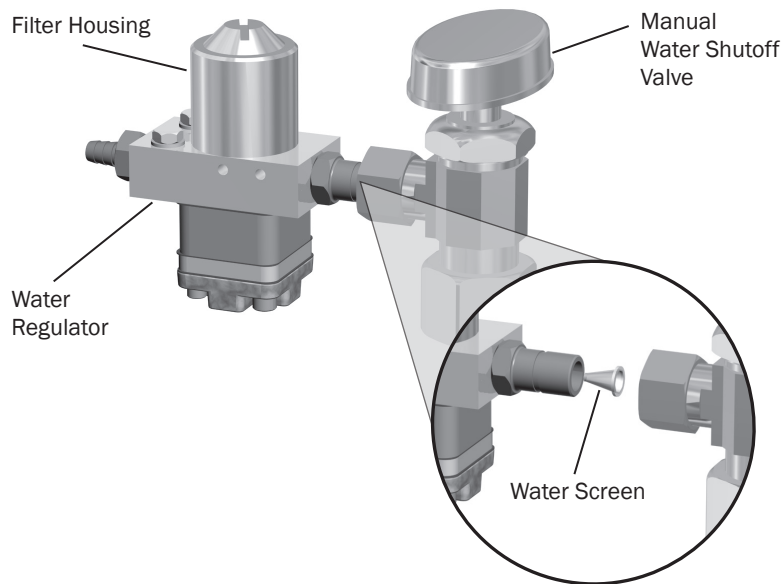

The manual water shutoff valves include a screen to prevent larger debris from entering the system. Periodically check and replace this screen to ensure unrestricted water flow.

To replace the water screen:

1. Flip the master toggle to the off position and close the shutoff valves (turn clockwise).
2. Use a 5/8" or adjustable wrench to loosen the compression nut on the manual water shutoff valve. Then pull the water regulator out of the shutoff valve.
3. Remove the old screen and replace with the new screen.
4. Reposition the water regulator in the manual shutoff valve outlet and tighten the compression nut.
5. Open the manual water shutoff valve (turn counterclockwise) and flip the master toggle to the on position.
6. Check the fittings for leaks.



**CAUTION** When you remove or replace the panel, take care not to damage any wiring or tubing. Verify that the panel is secure after you replace it.

The system utilities are located in the cabinet base and typically include the electrical outlet, as well as the system hookups for air, water, and vacuum. To access, open the doors of the cabinet, then lift and remove the bottom panel. For maintenance, contact your local authorized A-dec dealer.

### The Effective Size, Material and Maintenance of Filter

The filter is manufactured of 50 Micron Polypropylene or Polyethylene. They are to be replaced annually or after 1500 hours of clinical use.

## HVE/Saliva Ejector Valve Body Assembly Asepsis 541/545/551

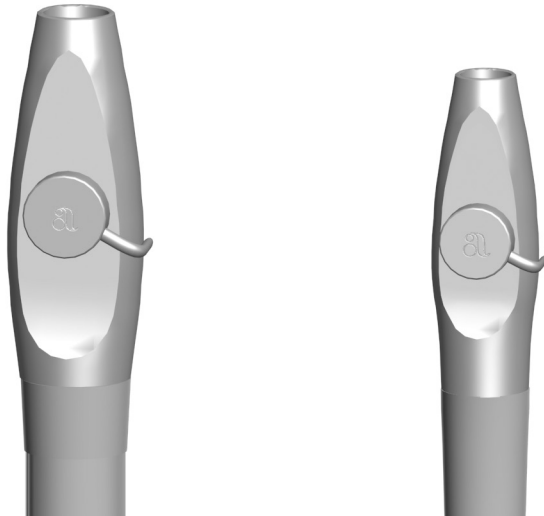

**NOTE** Vacuum lines should be cleaned at the end of each day by evacuating a detergent or water-based detergent-disinfectant through the system.

If you use barriers to protect the main body of the HVE and saliva ejector, replace the barriers after each patient. Clean and disinfect these instruments at the end of each day or after each patient if the barriers have been compromised. If you do not use barriers, or if you perform oral surgery, always clean and disinfect these instruments after each patient.

### Disinfection

To disinfect the A-dec HVE and saliva ejector valve body assembly without disconnection from the vacuum system:

1. Remove the vacuum tip from the HVE or saliva ejector.
2. Disinfect the valve body assembly with an intermediate-level, hospital-grade disinfectant. Follow the disinfectant manufacturer's Instructions for Use.
3. Operate the HVE and the saliva ejector valves several times to verify that they rotate smoothly.

## HVE/Saliva Ejector Valve Body Assembly Asepsis 541/545/551 *(continued)*

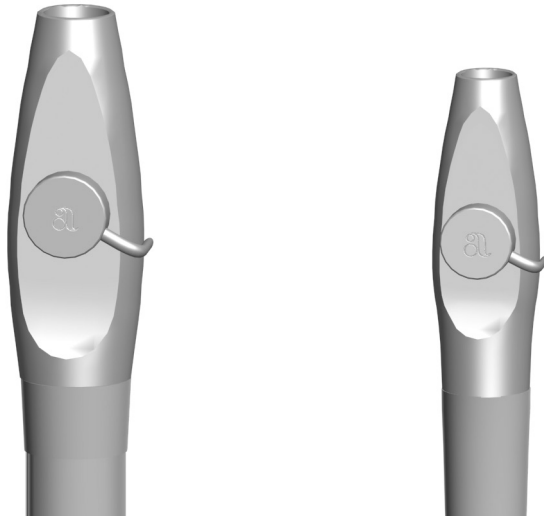

**NOTE** A-dec valve body assemblies are heat tolerant for sterilization. Users may sterilize at their discretion.

### Routine Maintenance and Sterilization

To routinely maintain and sterilize the A-dec HVE and saliva ejector when disconnected from the vacuum system (frequency determined by the user):

1. Turn off the vacuum or open the control valve before disconnecting the HVE or saliva ejector.
2. Remove the vacuum tip from the HVE or saliva ejector. Discard disposable vacuum tips.
3. Remove the HVE or saliva ejector valve body assembly from the vacuum line by pulling it away from the tubing at the tailpiece.
4. Disassemble the valve body assembly by pushing the control valve out of the HVE or saliva ejector valve body.
5. Inspect the O-rings. Remove and discard if damaged.
6. Clean undamaged O-rings with a soft brush, mild dishwashing liquid, and water. O-rings may be cleaned in place or removed and cleaned at the discretion of the user.
7. Clean all exterior and interior surfaces of the valve body and control valve with the brushes provided with the product (or equivalent), mild dishwashing liquid, and water. Lumens or channels of the valve body must be cleaned with a brush of the proper length and diameter. The brush must be long enough to extend through the lumen.
8. Rinse thoroughly with water.

## HVE/Saliva Ejector Valve Body Assembly Asepsis 541/545/551 *(continued)*

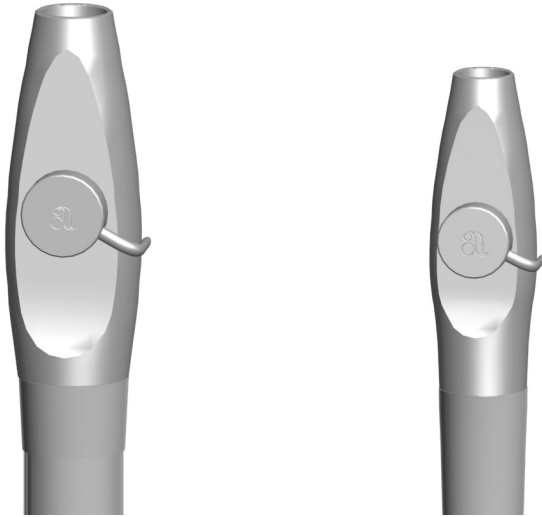

9. Disinfect the valve body components with an intermediate-level, hospital-grade disinfectant.
10. Allow the components to dry completely.
11. Sterilize the valve body assembly components at 132-134°C (270-273°F) for 4 minutes in a pre-vacuum sterilizer or 6 minutes in a gravity displacement sterilizer.



**CAUTION** Use only silicone lubricant when lubricating the black O-rings in A-dec instruments. Petroleum-based products will cause permanent damage to the O-rings.

12. Prior to use, replace O-rings as needed, lubricate O-rings with A-dec silicone lubricant, and reassemble the valve body assembly.
13. Reinstall the valve body assembly on the tubing tailpiece.
14. Operate the HVE and the saliva ejector control valves several times to verify that they rotate smoothly.

## HVE/Saliva Ejector Tip Asepsis 541/545/551

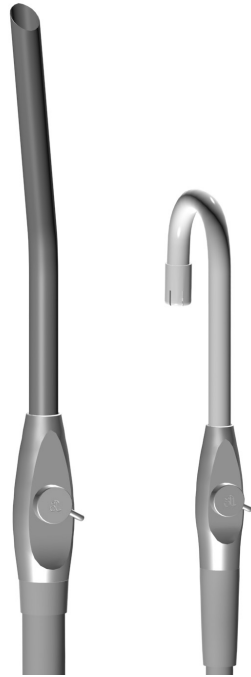

**NOTE** Select tips that are compatible with your HVE and saliva ejector openings. See “HVE/Saliva Ejector Tip Connections” on page 62 for specifications.

### Disposable Tips



**CAUTION** Disposable HVE and saliva ejector tips are not sterilizable and should not be reused.



Replace disposable HVE and saliva ejector tips after each use.

### Sterilizable Tips

Heat sterilize stainless steel HVE tips after each use. To clean and sterilize a stainless steel HVE tip:

1. Remove the tip from the HVE.
2. Clean and rinse the tip, then allow it to dry completely.
3. Sterilize the tip at 132-134°C (270-273°F) for 4 minutes in a pre-vacuum sterilizer or 6 minutes in a gravity displacement sterilizer.

## Bulb for Fiber-Optic Tubing

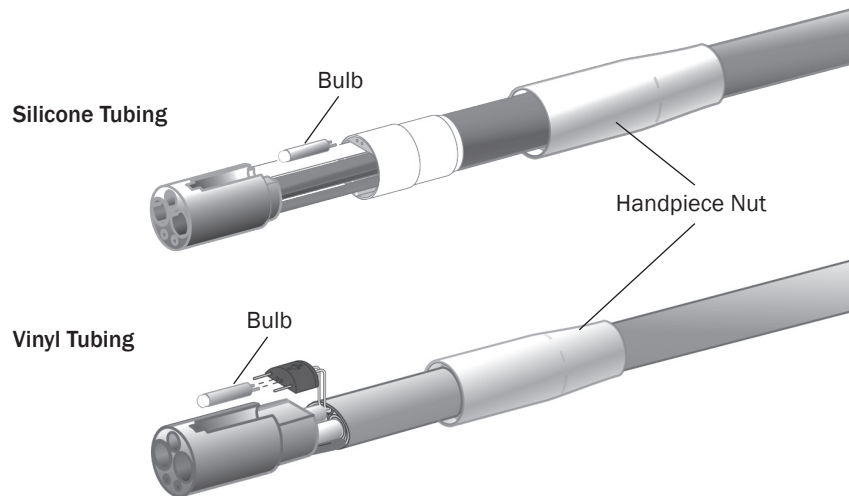

**IMPORTANT** To replace the bulb in your handpiece or quick-disconnect coupling, see your handpiece Instructions for Use.

To replace the bulb in your fiber-optic 5-hole silicone or vinyl tubing:

1. Disconnect the handpiece and quick-connector coupling from the tubing.
2. Pull back the metal handpiece nut.
3. Slide back the metal portion of the handpiece terminal (silicone tubing only).
4. Replace the bulb.
5. Reinsert the metal portion of the terminal into the plastic portion (silicone tubing only).
6. Carefully slide the handpiece nut back over terminal.



# Cuspidor with Support Center

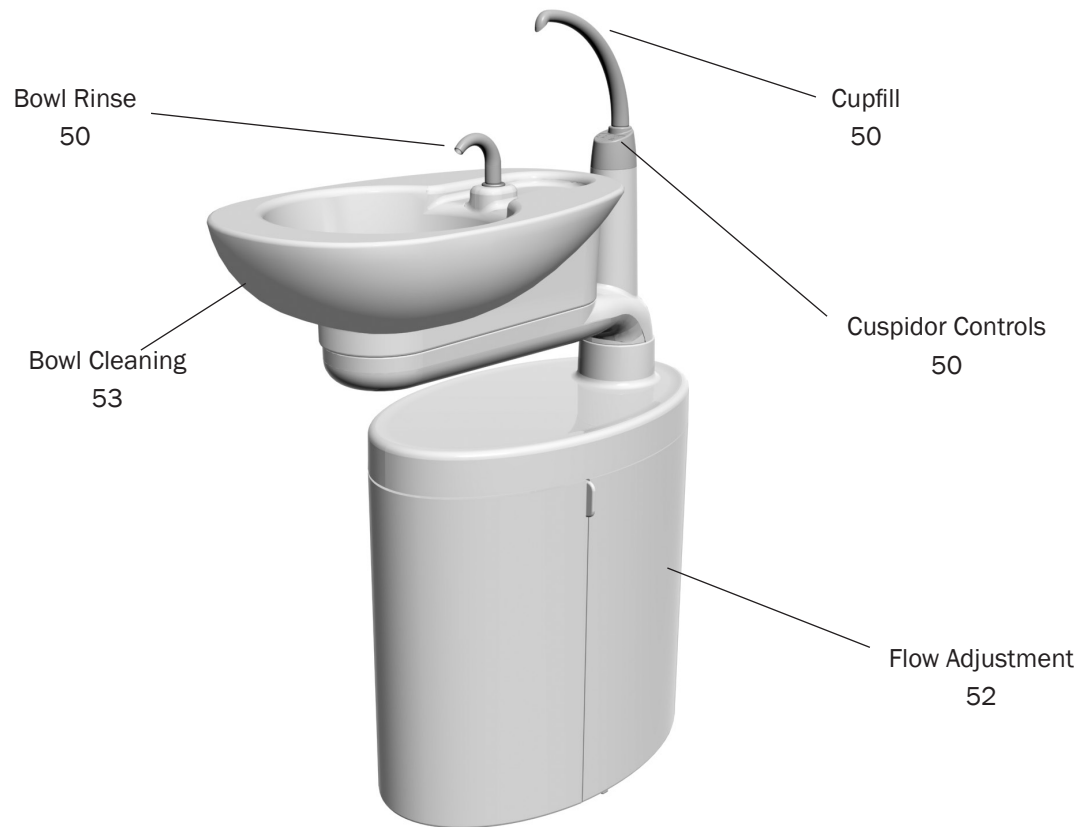

Operate / Adjust .....	50
Clean / Maintain.....	53

# Operate / Adjust the Cuspidor

## Operate the Cuspidor

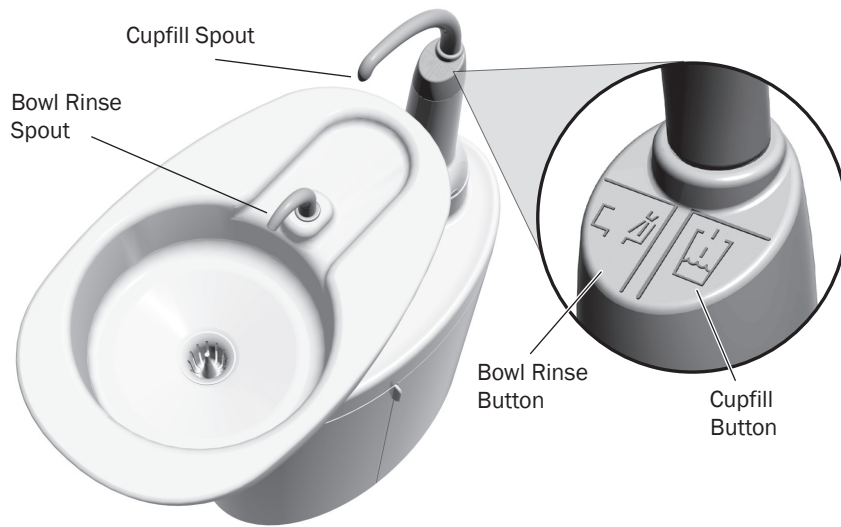

Standard Touchpad Shown

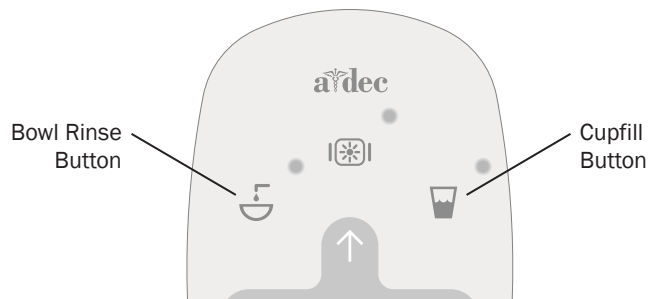

**IMPORTANT** Standard touchpad shown. For other touchpads, see your delivery system Instructions for Use.

## Turn On/Turn Off Cupfill and Bowl Rinse

Use the icons on the touchpad (☒, ☓), or the buttons on the cuspidor (☒, ☓) to control cupfill and bowl rinse functions.

Icon/Function	Actions/Options
☒ (or ☓) Cupfill	<ul style="list-style-type: none"> <li>Press once for a timed operation. The factory preset is a 2.5 second fill.</li> <li>Press and hold for manual operation.</li> </ul>
☓ (or ☒) Bowl Rinse	<ul style="list-style-type: none"> <li>Press once for a timed operation. The factory preset is a 30 second rinse.</li> <li>Press twice for continuous flow. Then press once to stop the flow.</li> <li>Press and hold for manual operation. Release to stop the flow.</li> </ul>

*Note: Touchpad symbols are proprietary to A-dec Inc.*

## Customize Cupfill and Bowl Rinse Timing on the Cuspidor



1. Press and hold ☒ and ☓ under the cupfill spout until you hear one beep, which indicates program mode is on.
2. Within five seconds, press and hold ☒ or ☓ for the desired time.
3. Three beeps confirm that your new settings are saved.

## Operate the Cuspidor *(continued)*

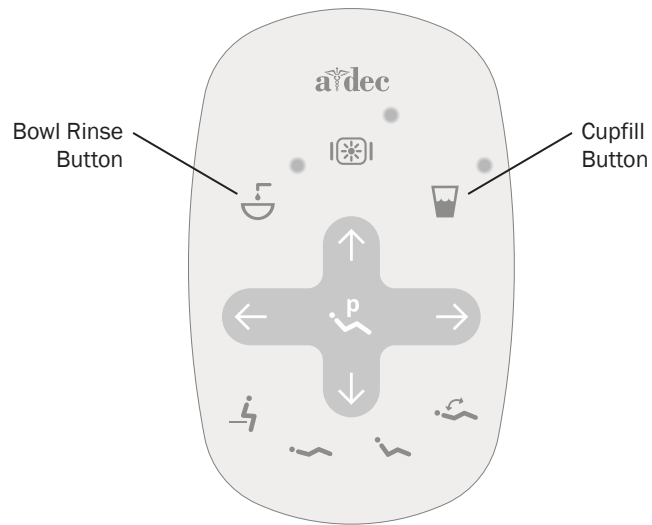
Standard Touchpad Shown



### Customize Cupfill and Bowl Rinse Timing on the Touchpad

1. Press and hold  until you hear one beep, which indicates program mode is on.
2. Within five seconds, press and hold  or  for the desired time.
3. Three beeps confirm that your new settings are saved.



**IMPORTANT** Standard touchpad shown. For other touchpads, see your delivery system Instructions for Use.

### Cuspidor Stop Switch

If an object gets caught under the cuspidor bowl as the chair is lowered, a stop switch will interrupt the chair motion to prevent damage. If the object becomes lodged, press  on the footswitch or touchpad to remove the object and resume normal operation.



**IMPORTANT** For more information about chair safety features, see your dental chair Instructions for Use.

## Adjust the Bowl Rinse Flow



The bowl rinse function should provide enough water to completely rinse the cuspidor bowl. If the flow is not sufficient, an adjustment can be made inside the support center:

1. Remove the side cover from the support center by pulling the lower edges of the cover out.
2. With the bowl rinse on, squeeze the pinch valve to reduce the flow. Release the valve to increase the flow.
3. For the best rinsing action, adjust the flow pattern by rotating the bowl rinse spout.

# Clean / Maintain the Cuspidor

## Maintain the Cuspidor and Drain



### Spouts and Bowl

The contoured spouts and smooth bowl of the cuspidor provide for quick and easy cleaning. Remember to empty and clean the bowl screen every time you clean the cuspidor.



**CAUTION** Do not remove the spouts when cleaning the cuspidor. This will help prevent cleaning solutions from damaging the equipment and contaminating the cupfill water.



**CAUTION** Do not empty the solids collector screen or bowl screen into the cuspidor. Doing so could plug the cuspidor drain. Dispose of the contents in an appropriate biohazard container according to the regulations specific to your location. After cleaning, always install the bowl screen in the cuspidor bowl to prevent debris from plugging the drain.

### Gravity Drain Tubing

At the end of each day, flush the cuspidor to remove debris from the flexible drain tubing. If the cuspidor is not flushed regularly, debris may build up and impair draining. To flush the cuspidor, run the bowl rinse for about 60 seconds.

### Maintenance Parts

For replacement cuspidor bowl screens, order p/n 75.0035.03.



# Dental Light

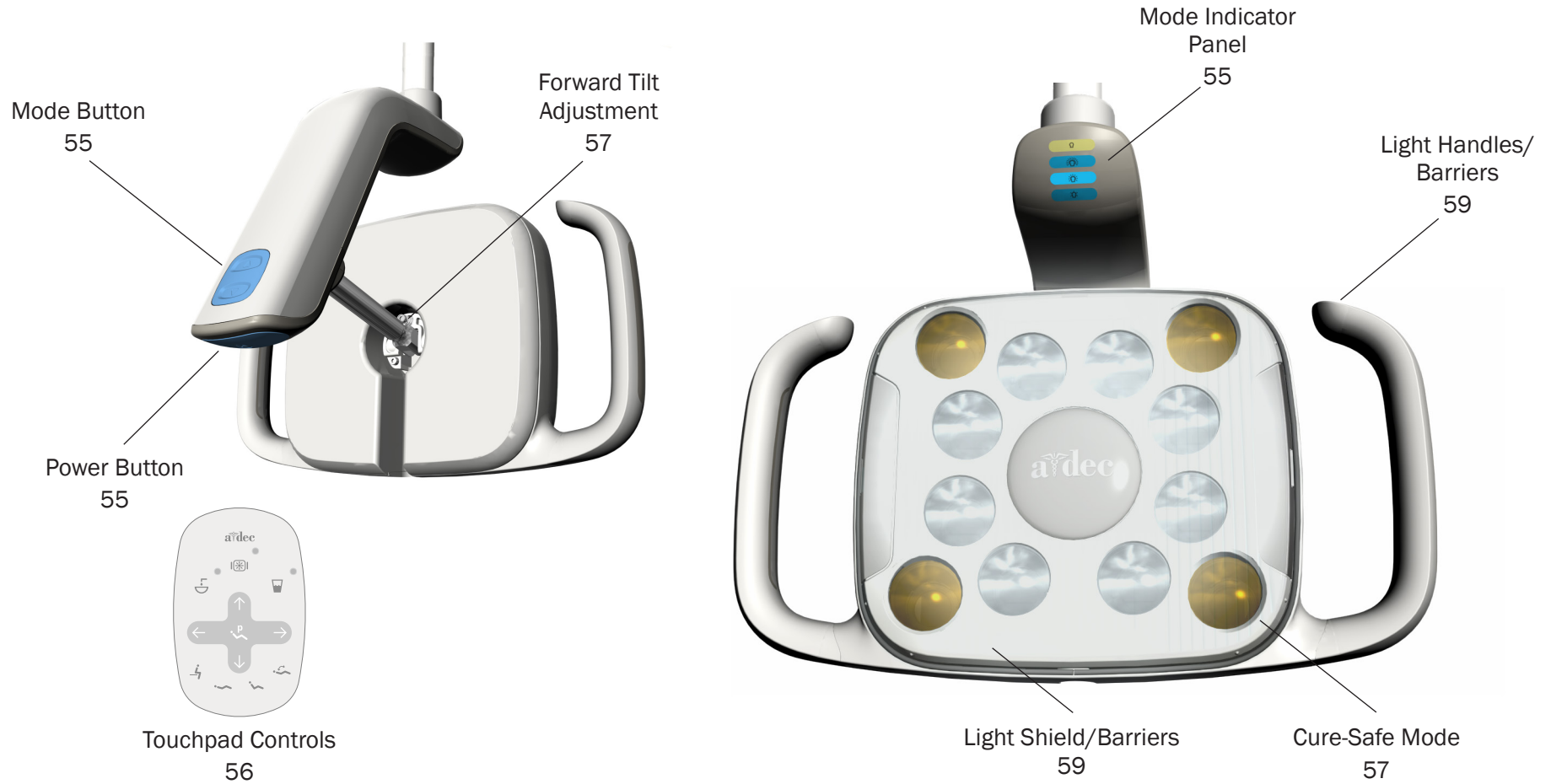

Operate / Adjust .....	55
Clean / Maintain.....	59
Specifications .....	61

# Operate / Adjust Dental Light

## Operate the Dental Light with Manual Controls

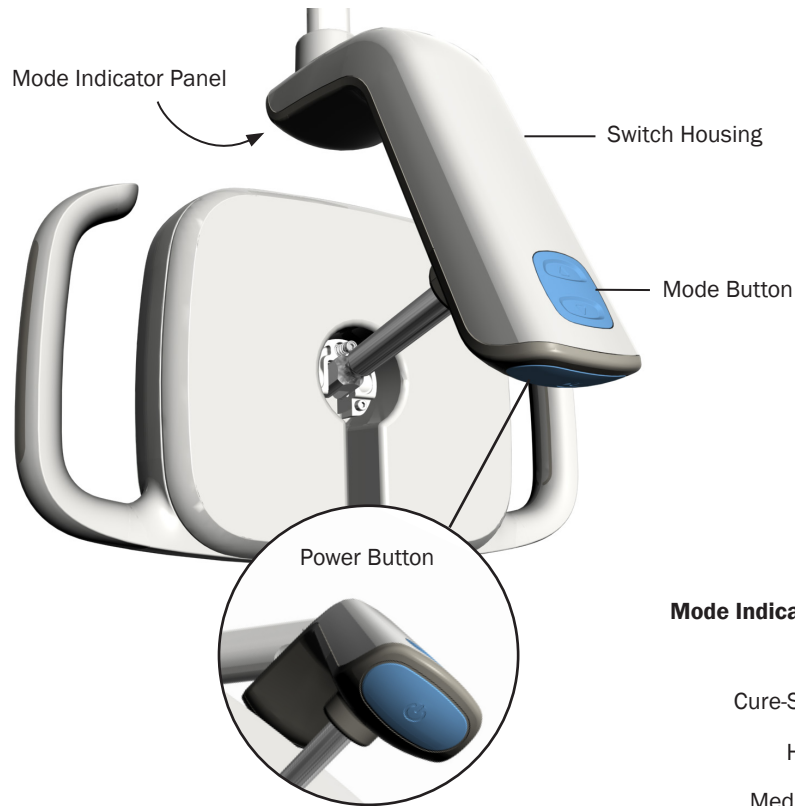

You can use the controls located on the light or on an A-dec touchpad to operate the dental light.

### Power Button

Press the power button, located at the bottom of the switch housing, to turn the light on or off. To eliminate a potential touch surface, use the back of your hand. If the light does not turn on, verify that the delivery system or chair power is on.

### Mode Button

Use the mode button to choose from four intensity levels: low, medium, high, and the cure-safe setting. The illuminated indicator shows the selected mode. The dental light retains the selected mode unless the entire system is turned off, which resets the light to medium intensity.

### Mode Indicator Panel

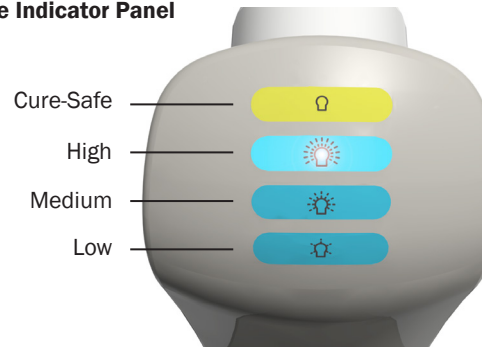

## Operate the Dental Light with Touchpad Controls

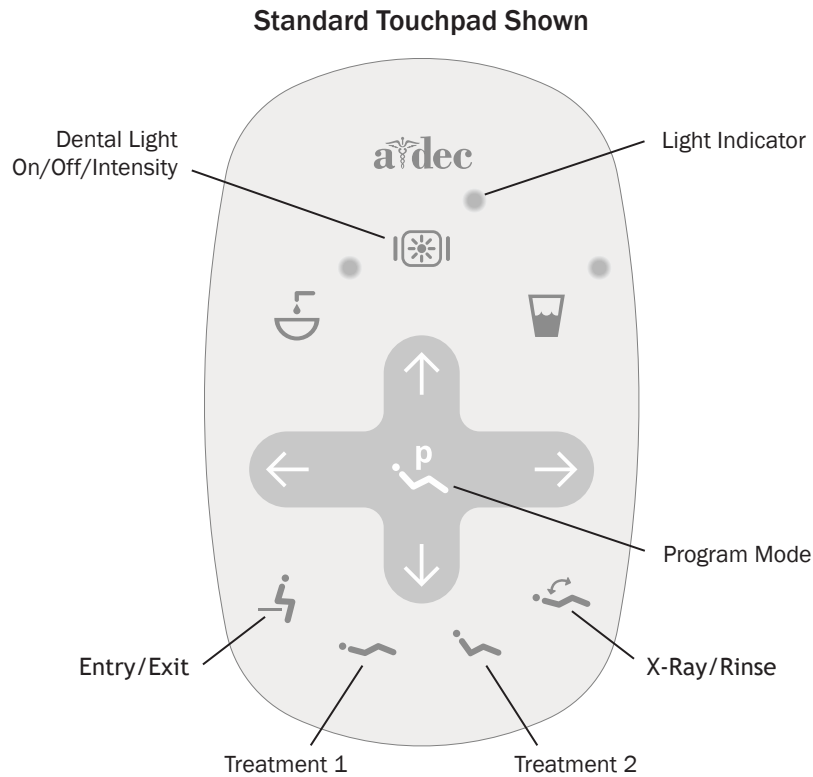

### Turn On/Turn Off the Dental Light and Change the Intensity

From the touchpad:

- Press to turn on the light.
- Repeatedly press and release to toggle between light intensity modes. The light indicator flashes continuously in cure-safe mode.
- Press and hold to turn off the light.

### Set the Dental Light Auto On/Off Function

When you press or on the touchpad, the dental light automatically turns on once chair motion stops. The light turns off when you press or .

Press and hold and at the same time to disable or enable the auto on/off function.

- **One beep** indicates this function is off.
- **Three beeps** indicate this function is on.



**IMPORTANT** Standard touchpad shown. For other touchpads, see your delivery system Instructions for Use.

Note: Touchpad symbols are proprietary to A-dec Inc.



## Lighting Features



### Cure-Safe Mode

The A-dec LED dental light cure-safe mode provides effective illumination while preventing the premature curing of photo-initiated composites, sealants, and adhesives. This mode uses a medium intensity light setting and a non-reactive wavelength of light.

### Focal Range

The dental light focus is set for optimum illumination between 16 – 30 inches (400 – 750 mm) from the oral cavity. This is a fixed focal range that cannot be adjusted.

## Range of Motion

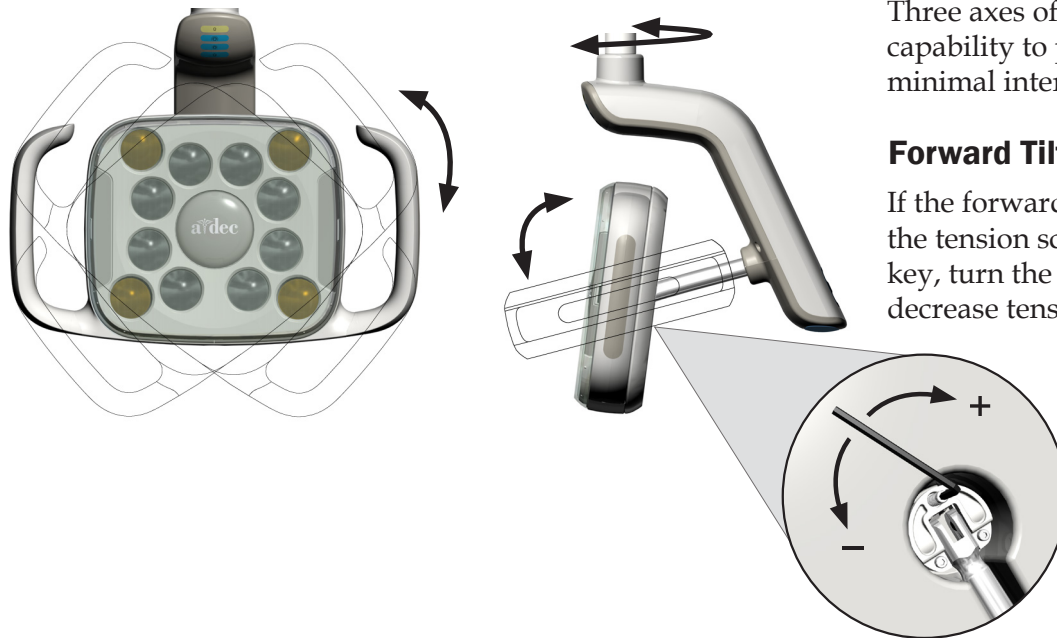

Three axes of rotation provide a wide range of motion. Use this capability to position the light for a clear view of tooth surfaces and minimal interference with other equipment and the dental team.

### Forward Tilt Adjustment

If the forward tilt motion of the light head is too tight or too loose, adjust the tension screw to improve the ease of movement. Using a 7/64" hex key, turn the screw clockwise to increase tension or counterclockwise to decrease tension.



**NOTE** Other tension adjustments require the removal of specific components. Please contact your authorized A-dec dealer if the light requires additional adjustments.

## Circuit Breaker Location

Under abnormal conditions, the circuit breaker interrupts the flow of electricity. If the circuit breaker trips, reset it by pushing the circuit breaker button on the power supply. The power supply is typically located in the utilities area of your dental chair. See the image below for the circuit breaker location. For non-chair based A-dec LED lights, use the operatory circuit breaker.

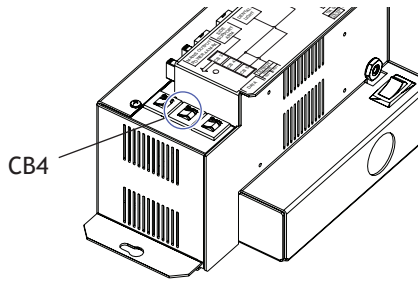

# Clean / Maintain Dental Light

## Dental Light Barriers

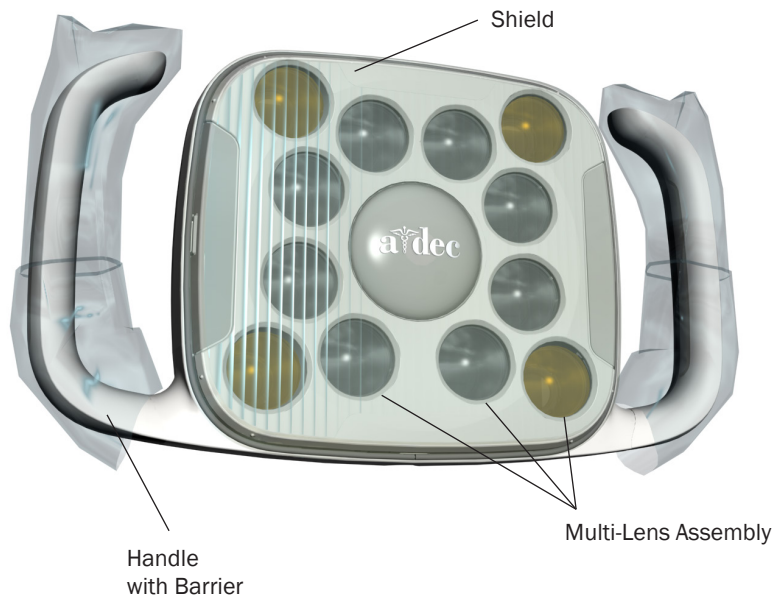

### Light Handles

Use barriers on the light handles to prevent cross contamination. The handles are shaped to easily accept the same disposable plastic sleeves designed for the air/water syringe.

### Light Shield



**CAUTION** Do not remove the shield unless absolutely necessary. The shield is fitted with a gasket to prevent dust and debris from entering the lens assembly. If liquid or dirt should bypass the gasket, the shield can be removed for cleaning. Use a flat-blade tool that won't damage the light housing. After removing the shield, do not touch or attempt to clean the multi-lens assembly or you may damage the components.

Barriers help protect and keep the dental light shield clean during procedures. Use only optically-correct barrier film that does not alter the light quality. A-dec recommends the SafeShield™ disposable barrier by Medicom® (see page 60 for ordering information).



If you do not use a barrier, carefully clean the light shield in place using a soft cotton cloth with non-abrasive soap and water.

### Mode and Power Buttons

Use one piece of barrier film to cover the mode and power buttons.



## Dental Light Maintenance Parts

Description	Part Number	
Medicom SafeShield Disposable Barrier <i>(package of 10)</i>	9565	
LED Lens Shield and Gasket	90.1343.00	

Contact your authorized A-dec dealer for available dental light maintenance parts.

# Specifications

---

## Dental Chair Specifications

### Maximum Capacity

Patient Load: 500 lb (227 kg)

## Dental Light Specifications

### Light Operation

Power:	22 watts maximum
Focal Range:	16 – 30" (400 – 750 mm)
LED Type:	white HB-LED, 90 CRI
Color Temperature:	white 5000 Kelvin
Light Pattern:	5.7" x 3.8" at 27.6" (145 mm x 95 mm at 700 mm)
Nominal Light Intensity:	
• cure-safe mode:	23,000 lux (2137 fc) 0 W/m <sup>2</sup> below 480 nm, light-cured composite safe
• high:	30,000 lux (2787 fc)
• medium:	25,000 lux (2323 fc)
• low:	15,000 lux (1394 fc)
Heat Output:	77 BTU/hour



**IMPORTANT** For electrical and utility specifications, identification of symbols, and other regulatory requirements, see the *Regulatory Information, Specifications, and Warranty* document (p/n 86.0221.00) available in the Resource Center at [www.a-dec.com](http://www.a-dec.com).



**NOTE** Specifications are subject to change without notice. Requirements may vary depending on your location. For more information, contact your authorized A-dec dealer.

## Delivery Systems Specifications

### System Accessory Load 532/533

Maximum accessory load capacity: 4 lb (1.8 kg)  
*(in addition to integrated accessories)*

### System Accessory Load 541/545

Maximum accessory load capacity: 20 lb (9.1 kg)  
*(in addition to integrated accessories)*

### HVE/Saliva Ejector Tip Connections

Standard 11 mm HVE: 0.438" (11.1 mm) diameter opening  
*(for standard HVE tips)*

Large bore 15 mm HVE: 0.594" (15.1 mm) diameter opening  
*(for large bore HVE tips)*

Standard 6 mm SE: 0.257" (6.5 mm) diameter opening  
*(for standard SE tips)*

### Solids Collector Screen/Filter

Maximum mesh opening size: 0.047" (1.194 mm)  $\cong$  1200  $\mu$ m

## Utility Specifications and Requirements

	Pressure/Vacuum	Flow	Other Requirements
Air	80 - 125 psi (550 - 860 kPa)	2.5 scfm (71 SL/min) minimum during normal use 7.5 scfm (210 SL/min) peak intermittent flow	<ul style="list-style-type: none"> <li>air quality to conform to ANSI/ADA specification #94</li> <li>humidity limit: dew point <math>\leq -20^{\circ}\text{C}</math> (at atmospheric pressure)</li> <li>oil contamination limit: <math>\leq 0.5 \text{ mg/m}^3</math></li> <li>particulate contamination limit: <math>\leq 100</math> particles per cubic meter for 1 - 5 <math>\mu\text{m}</math> particle size</li> <li>90 psi (621 kPa) (minimum unregulated) is recommended for delivery systems with Advanced Air</li> <li>air filter effective mesh size is 50 microns</li> </ul>
Water	60 $\pm$ 20 psi (410 $\pm$ 140 kPa)	1.5 gpm (5.7 L/min) minimum, not to exceed 40 $^{\circ}\text{C}$ (104 $^{\circ}\text{F}$ )	<ul style="list-style-type: none"> <li>water supply to meet local plumbing codes, including backflow prevention</li> <li>pH limits between 6.5 and 8.5</li> <li>maximum particle size &lt;100 <math>\mu\text{m}</math></li> <li>water hardness limit is less than 2.14 mmol/l (&lt;12<math>^{\circ}\text{dH}</math>)</li> <li>water filter effective mesh size is 50 microns</li> </ul>
Vacuum	Wet: 10 $\pm$ 2 inches of Hg (34 $\pm$ 7 kPa) dry/semidry: 4.5 $\pm$ 1 inches of Hg (16 $\pm$ 3.5 kPa)	9 scfm (255 SL/min) minimum 12 scfm (340 SL/min) minimum	solids filter maximum mesh opening size: 0.043" (1.080 mm) $\square$ 1080 $\mu\text{m}$ A-dec 200, Performer 8000/8200/8500, 2671/2615, 4631/4635) 0.047" (1.194 mm) $\square$ 1200 $\mu\text{m}$ A-dec 351/361/362/363, 551/561m.

## High Volume Evacuator (HVE) and Saliva Ejector (SE) Head Loss With Respect to Flow of 551 Assistant's Instrumentation on 511B Chair

Tubing and HVE/SE	90 NL/min (3.18 SCFM)	150 NL/min (5.30 SCFM)	200 NL/min (7.06 SCFM)	250 NL/min (8.83 SCFM)	300 NL/min (10.59 SCFM)	350 NL/min (12.36 SCFM)	*400 NL/min (14.13 SCFM)
11 mm HVE (standard bore) valve with 13 mm Easy Flex Tubing (p/n 11.1357.00)	0.33 in-Hg 1.12 kPa	1.09 in-Hg 3.69 kPa	1.88 in-Hg 6.37 kPa	2.97 in-Hg 10.06 kPa	4.51 in-Hg 15.27 kPa	6.65 in-Hg 22.52 kPa	9.54 in-Hg 32.31 kPa
15 mm HVE (large bore) valve with 16 mm Easy Flex Tubing (p/n 11.1287.01)	0.11 in-Hg 0.37 kPa	0.32 in-Hg 1.08 kPa	0.54 in-Hg 1.83 kPa	0.82 in-Hg 2.78 kPa	1.17 in-Hg 3.96 kPa	1.62 in-Hg 5.49 kPa	2.16 in-Hg 7.31 kPa
11 mm HVE (standard bore) valve with 16 mm Easy Flex Tubing (p/n 11.1288.01)	0.20 in-Hg 0.68 kPa	0.54 in-Hg 1.83 kPa	0.91 in-Hg 3.08 kPa	1.41 in-Hg 4.77 kPa	2.07 in-Hg 7.01 kPa	2.93 in-Hg 9.92 kPa	4.03 in-Hg 13.65 kPa
11 mm HVE (standard bore) valve with 13 mm PVC Tubing (p/n 11.1286.01)	0.38 in-Hg 1.29 kPa	1.03 in-Hg 3.49 kPa	1.70 in-Hg 5.76 kPa	2.57 in-Hg 8.70 kPa	3.72 in-Hg 12.60 kPa	5.22 in-Hg 17.68 kPa	7.14 in-Hg 24.18 kPa
SE (standard bore) valve with 10 mm Easy Flex Tubing (p/n 12.1228.01)	5.03 in-Hg 17.03 kPa	Exceeds 12 in-Hg (40.64 kPa) at flow rates above ~125 NL/min.					
SE (standard bore) valve with 6 mm PVC Tubing (p/n 11.1227.01)	8.89 in-Hg 30.10 kPa	Exceeds 12 in-Hg (40.64 kPa) at flow rates ~100 NL/min.					

\*Note: 400 NL/min values are calculated extrapolations from previously measured data points.

## Utility Specifications

Utility	Finish	Requirements
Air	Protrude 1" to 2" (25 mm to 51 mm) for 1/2" (13 mm) compression	<ul style="list-style-type: none"> <li>Right-angle manual shutoff valve with 3/8" compression outlet supplied and installed by the contractor, with the top of the handle no higher than 3-3/4" (95 mm) above the finished floor.</li> <li>80-125 psi (550 to 860 kPa), 2.5 scfm (71 SL/min) minimum, during normal use (7.5 scfm [210 SL/min] peak intermittent flow).</li> <li>Flush lines prior to making connections to dental equipment.</li> </ul>
Water*	Protrude 1" to 2" (25 mm to 51 mm) for 1/2" (13 mm) compression	<ul style="list-style-type: none"> <li>Right-angle manual shutoff valve with 3/8" compression outlet supplied and installed by the contractor, with the top of the handle no higher than 3-3/4" (95 mm) above the finished floor.</li> <li>60±20 psi (410 ± 140 kPa), 1.5 gpm (5.7 L/min) minimum, not to exceed 40°C (104°F).</li> <li>Flush lines prior to making connections to dental equipment.</li> </ul>
Central vacuum	Protrude 1" (25 mm) for 5/8" (16 mm) O.D. tubing and other specified by the central vacuum supplier	<ul style="list-style-type: none"> <li>Wet systems: 10±2 inches of Hg (34±7 kPa), 9 scfm (255 SL/min) minimum.</li> <li>Dry/semi-dry systems: 4.5±1 inches of Hg (16±3.5 kPa), 12 scfm (340 SL/min) minimum.</li> </ul>
Gravity Drain**	Protrude 1" (25 mm) for 1-1/2" (38 mm) nominal pipe	<ul style="list-style-type: none"> <li>Place trap in line, conforming to local codes, contractor-supplied.</li> <li>Waste water drain must have a minimum slope of 1/4" per foot (21 mm per meter) and accommodate a flow of 4.5 gpm (17 L/min) without overflow.</li> <li>Floor mount only. Not recommended for wall mount utilities.</li> </ul>
Electrical	1/2" (13 mm) conduit and electrical box with a hospital-grade quad power receptacle	<ul style="list-style-type: none"> <li>Conduit, electrical box, and power receptacle supplied and installed by the contractor (wired as per code).</li> <li>Electrical box should be oriented vertically, with the top no higher than 5" (127 mm) above the finished floor.</li> </ul>

\* The delivery system comes with a self-contained water bottle. Municipal water is only required if the equipment configuration includes a cuspidor or if the facility has special requirements.

















\*\* Gravity drains are needed only on systems with a cuspidor.















# Dental System Specifications

## Identification of Symbols

These symbols appear on the actual product or are used in documentation to alert the user about cautions, warnings, hazards, or tips

Symbol	Description
	Recognized by Underwriters Laboratories Inc. with respect to electric shock, fire and mechanical hazards only in accordance with ANSI/AAMI ES60601-1, CAN/CSA C22.2 No. 60601-1, and Amendment 1.
	Classified by Underwriters Laboratories Inc. with respect to electric shock, fire and mechanical hazards only in accordance with ANSI/AAMI ES60601-1, CAN/CSA C22.2 No. 60601-1, Amendment 1, and 80601-2-60.
	<b>ICV &amp; Preference ICC:</b> UL listed to UL 61010A-1 and Canadian CAN/CSA C22.2, No.1010.1-92 safety standards. <b>Simulator:</b> UL listed to UL 61010-1 (3rd Edition), BS EN 61010-1 (3rd Edition) and Canadian CAN/CSA C22.2, No. 61010-1-12 (3rd Edition) safety standards.
	Conforms to applicable European Directives (refer to Declaration of Conformity).
	Conforms to MDD 93/42/EEC for Class IIa devices.
	Protective earth (ground).
	Functional earth (ground).
	Type B applied part.
	Caution: Hot surface.
	Electrical and electronic waste. Do not dispose of with domestic waste.
	Date of manufacture.
	Manufacturer of equipment.
	Sterilizable up to the stated temperature.
	VAC symbol.
	VDC symbol.
	VAC/VDC symbol.

Symbol	Description
<b>REF</b>	Model Number (Catalog Number).
<b>SN or S/N</b>	Serial Number.
<b>PN or P/N</b>	Part Number.
	General mandatory action sign. Not a caution. Take note of additional important instructions. e.g., NOTE: Assemble parts as shown.
	Advisable to consult accompanying documents. e.g., IMPORTANT: For more information, see the A-dec Equipment Asepsis Guide (p/n 85.0696.00).
	Mandatory to consult the manual. e.g., IMPORTANT: When installing this light on an A-dec 311 light post, use the instructions that came with the post instead of this guide.
	Caution. Failure to follow instructions could result in damage to product or minor injury. e.g., CAUTION: Do not overtighten the adjustment screw. Overtightening could break the screw.
	Biohazard. Failure to follow instructions could increase risk of infection. e.g., DANGER: Infectious waste may be present. Follow asepsis protocol to prevent cross contamination.
	Danger. Failure to turn off the power before you begin this procedure can lead to electrical shock. e.g., DANGER: Disconnect the main power or shut off the main power before servicing. Failure to turn off the power before you begin this procedure can lead to electrical shock.
	Warning. Failure to turn off the power before you begin this procedure can lead to product damage and result in serious injury or death. e.g., WARNING: Turn off the power before removing the pump cover. Failure to turn off the power before you begin this procedure can lead to product damage and result in serious injury or death.
	Single use only. e.g., CAUTION: Disposable HVE and saliva ejector tips are not sterilizable and should not be reused.
	Temperature shipping and storage limits.
	Relative humidity shipping and storage limits.
	This side up.
	Fragile.
	Keep dry.

## Electrical Rating

A-dec Product	Frequency (Hz)	Voltage Range (VAC)	Maximum Current (Amps)
<b>Delivery Systems</b>			
Systems with 300W Power Supply	50-60	100/110-120/220-240	Input = 3.1/2.8/1.4 Output with optional duplex on 2671/2615, 2561/2562 = 7 Amps max.

## Environmental Specifications

Temperature/Humidity	Specification
Storage/Transportation Temperature	-20 °F to 122 °F (-29 °C to 50 °C) - Relative humidity: 10 – 95%.
Operating Temperature	50 °F to 104 °F (10 °C to 40 °C) - Relative humidity: 10 – 95%.
Indoor Use	Altitude up to 2,000 m (6,563'), installation category II, pollution degree 2.

## Electromagnetic Compatibility

This equipment has been tested and found to comply with the limits for medical devices in YY0505-2012. These limits are designed to provide reasonable protection against harmful interference in a typical medical installation. In the event of interference, power the devices from separate mains supplies and/or increase the physical distance between devices. Contact A-dec Customer Service if you have any questions.

## Decommissioning and Disposal of A-dec Equipment

A-dec dental equipment removed from service should be decommissioned in accordance with local regulatory requirements. Circuit boards and electrical cabling should be recycled as electrical salvage. Aluminum, brass, iron, and steel components should be recycled as metal salvage. Molded plastic components include mold marks indicating the type of plastic and should be recycled accordingly. The cuspidor, waste lines from the cuspidor, and extraction lines should be treated as biologically contaminated materials and handled with appropriate precautions during dismantling. Any material unsuitable for recycling should be disposed of appropriately. For specific questions regarding material type, please contact A-dec Customer Service. For decommissioning information on associated equipment from other manufacturers, refer to the documentation from the manufacturer.

### Electromagnetic Compatibility (EMC)

Special precautions relating to electromagnetic compatibility (EMC) are required for this device and this device must be installed and used as set forth in the EMC section herein. Portable and mobile radio frequency communication equipment may affect the equipment.

This device must be operated with the attached cable and accessories. The cable information is described as below:

Cable Name	Length
Chair power line	1.8 m
Footswitch power line	1.0 m

Except for cables (transducers) offered as spare parts for internal components, the use of other accessories and cables (transducers) may lead to increased emission of the device or system or decreased immunity.

The device or system shall not be put close to or stacked with other devices; if the same must be so put or stacked, please observe and verify whether it operates normally with its configuration adopted.

Basic performance:

Name	Description
Standby mode	During the immunity test, the chair can work normally without any misaction and the oral lamp is steady on.
Work mode	During the immunity test, the oral lamp is steady on and the chair work normally without any misaction.

### Guidance and Statement of the Manufacturer - Electromagnetic Emission

This device is expected to be used in the electromagnetic environments as provided below and buyers or users shall make sure it is used in such electromagnetic environments:

Emission Test	Conformity	Electromagnetic Environment - Guidance
RF Emission GB 4824	1 group	This device is suitable for use in all facilities, including being used at home and connected to residential public LV power supply networks directly for household use.
RF Emission GB 4824	Class B	
Harmonic radiation GB 17625.1	Class A	
Voltage fluctuation/flicker emission GB 17625.2	Conforming	

## Guidance and Statement of the Manufacturer - Electromagnetic Immunity

This device is expected to be used in the electromagnetic environments as provided below and buyers or users shall make sure it is used in such electromagnetic environments:

Immunity Test	Test Level	Conforming Level	Electromagnetic Environment - Guidance
Electrostatic discharge (ESD) GB/T 17626.2	±6kV contact discharge ±8kV air discharge	±6kV (contact) ±8kV air	This device uses RF energy only for its internal functions and thus it has low RF emission and has a very low possibility to interfere nearby electronic devices.
Electrical fast transient burst GB/T 17626.4	±2kV power line ±1kV input/output line	±2kV power line N/A	The quality of the network power supply shall meet the requirements of typical commercial or hospital environments.
Surge GB/T 17626.5	±1kV line to ground ±2kV line to ground	±1kV line to ground ±2kV line to ground	The quality of the network power supply shall meet the requirements of typical commercial or hospital environments.
Voltage sag, short interruption and voltage change on power supply input line GB/T 17626.11	<5% UT, duration: 0.5 period (on UT, > 95% voltage sag) 40% UT, duration: 5 periods (on UT, 60% voltage sag) 70% UT, duration: 25 periods (on UT, 30% voltage sag) <5% UT, duration: 5s (on UT, >95% voltage sag)	<5% UT, duration: 0.5 period (on UT, > 95% voltage sag) 40% UT, duration: 5 periods (on UT, 60% voltage sag) 70% UT, duration: 25 periods (on UT, 30% voltage sag) <5% UT, duration: 5s (on UT, >95% voltage sag)	The quality of the network power supply shall meet the requirements of typical commercial or hospital environments. In case of need of continuous operation of this device during power interruption, UPS or battery is recommended for power supply.
Power frequency magnetic field (50Hz) GB/T 17626.8	3A/m	3A/m	The power frequency magnetic fields shall have the level and characteristics of those used in typical commercial or hospital environments.
Notes: UT refers to AC network voltage before applying the test voltage.			

### Guidance and Statement of the Manufacturer - Electromagnetic Immunity

This device is expected to be used in the electromagnetic environments as provided below and buyers or users shall make sure it is used in such electromagnetic environments:

Immunity Test	Test Level	Conforming Level	Electromagnetic Environment - Guidance
RF conduction GB/T 17626.6 RF radiation GB/T 17626.3	3V (effective value) 150kHz - 80MHz 3V/m 80MHz-2.5GHz	3V (effective value) 3V/m	Portable and mobile RF communication instrument shall not be used with a closer distance to any part (including cables) of this device than the recommended isolation distance. Such a distance shall be calculated based on the corresponding formula relevant to the transmitter frequency.  Recommended isolation distance $d = 1.2 \sqrt{(P)} \text{ 150kHz-80MHz}$ $d = 1.2 \sqrt{(P)} \text{ 80MHz-800MHz}$ $d = 2.3 \sqrt{(P)} \text{ 800MHz-2.5GHz}$ Wherein: P- the maximum rated output power of transmitter provided by the transmitter manufacturer (unit: W);d - the recommended isolation distance (unit: m). The field intensity of the stationary RF transmitter is determined by the electromagnetic field survey* and shall be lower than the conforming level <sup>b</sup> in each frequency range. Interference may exist around the device with the following symbol.  
Note 1: Adopt the formula for higher-frequency band at 80MHz and 800MHz frequency points. Note 2: The Guidance may not be suitable for all situations and the electromagnetic transmission may be affected by the absorption and reflection of buildings, objects and human bodies. a The field intensity of a stationary transmitter, such as wireless (cellular/cordless) telephone and ground movable wireless radio station, amateur radio, amplitude modulation and frequency modulation wireless radio and television broadcasting cannot be accurately predicted in theory. In order to evaluate the electromagnetic environment of stationary RF transmitter, the electromagnetic field should be surveyed. If the field strength of the place where the device is located is measured to be higher than the applicable RF above, please observe and verify whether the device operates normally. Take supplementary measures, such as readjusting the direction or position of the device in case that any abnormal performance is observed. b The field intensity within 150kHz-80MHz shall be lower than 3V/M.			

### Recommended Isolation Distance Between the Portable and Mobile RF Communication Instrument and This Device

This device is expected to be used in an electromagnetic environment with controlled RF radiation disturbance. Based on the maximum rated output power of the communication device, buyers or users may prevent electromagnetic interference by maintaining a minimum distance between the portable and mobile RF communication instrument (transmitter) and the device according to the following recommendations.

Maximum Rated Output Power of the Transmitter (W)	Total Distance Corresponding to Different Transmitter Frequency/m		
	150kHz - 80MHz $d = 1.2\sqrt{(P)}$	80MHz - 800MHz $d = 1.2\sqrt{(P)}$	800MHz - 2.5GHz $d = 2.3\sqrt{(P)}$
0.01	0.12	0.12	0.23
0.1	0.38	0.38	0.73
1	1.2	1.2	2.3
10	3.8	3.8	7.3
100	12	12	23

For maximum rated output powers of the transmitter not listed in the above table, the recommended isolation distance is d (unit: m), which can be determined by the formula in the corresponding transmitter frequency column; wherein, P is the maximum rated output (unit: W) of the transmitter provided by the transmitter manufacturer.

Note 1: Adopt the formula for higher-frequency band at 80 MHz and 800MHz frequency points.

Note 2: The Guidance may not be suitable for all situations and the electromagnetic transmission may be affected by the absorption and reflection of buildings, objects and human bodies.





**Registrant/Manufacturer:**  
**A-dec, Inc.**

2601 Crestview Drive  
Newberg, Oregon 97132  
United States  
Tel: 1.800.547.1883 within USA/CAN  
Tel: +1.503.538.7478 outside USA/CAN  
Fax: 1.503.538.0276  
www.a-dec.com

**A-dec Australia**

Unit 8  
5-9 Ricketty Street  
Mascot, NSW 2020  
Australia  
Tel: 1.800.225.010 within AUS  
Tel: +61.(0).2.8332.4000 outside AUS

**Agent/After Sales Service:**  
**A-dec China**

A-dec (Hangzhou) Dental Equipment Co., Ltd.  
528 Shunfeng Road  
Building 5, No.528 Shun Feng Road, Tang Qi Town, Yu Hang District  
Hang Zhou, Zhe Jiang, China, 311100  
Tel: 400.600.5434 within China  
Tel: +86.571.89026088 outside China  
Registration Certificate No.: 国械注进20152170629  
Product Technical Requirements No.: 国械注进20152170629

**A-dec United Kingdom**

Austin House  
11 Liberty Way  
Nuneaton, Warwickshire CV11 6RZ  
England  
Tel: 0800.ADEC.UK (2332.85) within UK  
Tel: +44.(0).24.7635.0901 outside UK



86.0879.00 Rev A  
Date of Issue 2020-06-25  
Copyright 2021 A-dec, Inc.  
All rights reserved.